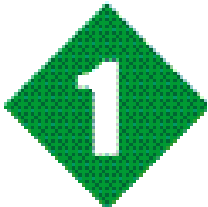

TABLE of CONTENTS

	CARBURETORS	7-92
	FUEL INJECTION	93-136
	THROTTLE BODIES	137-142
	FUEL PUMPS	143-162
	INTAKE MANIFOLDS	163-192
	SUPERCHARGERS	193-220
	CYLINDER HEADS	221-224
	SysteMAX™	225-232
	WATER PUMPS	233-244
	DRESS-UP	245-248
	BATTERY	249-250
	STREET & TRUCK AVENGER™ SYSTEMS	251-266
	POINT-OF-SALE / MERCHANDISING AIDS	267-269
	INDEX & WARRANTY	270-304

Holley and other manufacturers have developed a program whereby all emission-sensitive products can be identified by placing color-coded labels on product packaging and listing corresponding numeric codes next to each part number. The color codes and explanations are as follows:

GREEN



The product accompanying this document has been granted a California Air Resources Board (CARB) exemption, an "EO" number, or is a direct or consolidated replacement part. It is 50-state legal, per the manufacturer's application guide.

BLUE



The manufacturer of the product accompanying this document represents that it has not been found, nor is believed to be, unlawful for use under provisions of the Clean Air Act, per the manufacturer's application guide. This product is not legal for sale or use in the State of California (or in states which have adopted California emission standards) except on pre-emission-controlled motor vehicles/motor vehicle engines (pre-1966 model year).

AMBER



The product accompanying this document is legal only for off-highway use (except in California or states that have adopted California emission standards), racing use or for use on pre-emission-controlled motor vehicles/motor vehicle engines (pre-1966 domestic vehicles certified to California standards, pre-1968 domestic vehicles certified to federal standards and all pre-1968 foreign vehicles), per the manufacturer's application guide.



How To Use This Catalog

***Welcome to the
2003 Holley
and Weiland
performance
products catalog!***

This catalog is organized so that all major product lines, such as carburetors, fuel injection, intake manifolds, water pumps, ignition, etc., appear in their own catalog sections. These sections are uniquely identified by page headings and edge bars that correspond directly to the Table of Contents page, shown here.



Each major product section has its own identifying cover page, with a mini index to help find products faster.

Within major product lines, sub-categories are identified by secondary product headings, in bold. Where appropriate, more detailed product listings and applications have been organized and charted into a user-friendly sequence. Line shading is employed to enhance readability.



Lastly, detailed technical and mechanical product information is provided in each product section, to explain how products work. The Holley tech line and website address is located on each spread for easy access to Holley.

Tech Line: 270-781-9741

3

History

Holley Heritage - 100 Years of Power Since 1903

It was more than 100 years ago that brothers George and Earl Holley began building and racing motorcycles in rural Pennsylvania. By 1897 they had designed and built their first automobile, a three-wheeled, single-cylinder design that was able to reach an impressive speed of 30 miles per hour. Two years later they formed the Holley Motor Company.



Soon many airlines and governments were using Holley carburetors on their air fleets. In 1935 a variable venturi carburetor was developed to overcome aircraft carburetor icing problems. This unit was first used on the DC-3 airplane and later, during World War II, on Packard-powered PT boats as well as the B-25s used in Jimmy Doolittle's air raid on Tokyo. About half of all the carburetors used by the US during World War II bore the Holley name. Following the war, Holley concentrated on keeping up with the requirements of car manufacturers who, in turn, were trying to meet the demands of a car-hungry public. In 1949 new automotive ignition components were developed as well as an advance-design four-barrel carburetor to keep pace with the growing power requirements of American-made automobiles. During this time, Holley also entered the automotive after-market by supplying carburetor repair kits and genuine Holley parts to garages and service stations.



In 1903, at the urging of Henry Ford, the Holley brothers entered the carburetor business and became industry leaders in fuel system technology. The business was incorporated under the name Holley Brothers Company. Their first original carburetor, called the "iron pot", debuted in 1904 and it was designed for application on the curved-dash Oldsmobile. Later it became standard equipment on the Ford as well.



To better service their customers the Holley Brothers Company relocated to Detroit, MI in 1907. The company business continued to expand through World War I and beyond. 1927 saw the development of a carburetor for the Ford Model A and the creation of an aviation division, driven primarily by Earl's interest in airplanes.



The decade of the 1950s saw more growth and product development necessitated by the continued feverish pace of engine development and new car introductions by the automotive "Big 3". In 1957 the famous Holley model 4150 four-barrel carburetor was introduced on the 1957 Ford Thunderbird. This was the beginning of the modular carburetor as we know it today. The Holley model 4150 was very highly regarded by all and in later years it was standard for any performance-built engine. It was also original equipment on many 60s-era Detroit muscle cars. Another notable Holley carburetor model, the DOMINATOR, made its debut in 1968.



1968 proved to be a pivotal year in Holley history with the Colt Industries merger. The net result of the merger was that Holley was now able to focus 100% of its attention on the automotive industry. It was realized that only by having a separate and dedicated aftermarket sales and marketing organization could the full potential of this market be realized. The Colt merger provided a major boost to this thinking and the Holley Aftermarket Sales Department was created.



The 1970's saw continued expansion of both the Holley original equipment and aftermarket sales operations. The latter introduced many new and innovative automotive performance fuel system and ignition products for street or race. Sales success and product growth continued in the aftermarket and by the mid-1980's a new Holley Replacement Parts Division was created.

Holley entered the 1980's well positioned to meet the growing demand for fuel efficient cars and the only carburetor manufacturer in the world making the entire system: fuel pumps, fuel lines, fuel filters, carburetors and intake manifolds. By 1985 Holley entered the fuel injection market with its Pro-Jection line of fuel injection conversion kits for carbureted vehicles.

In 1994, the Holley Replacement Parts Division was renamed Holley Performance Products. That same year, the Holley headquarters was relocated to Bowling Green, KY. In May of 1998, the senior management team of Holley Performance Products purchased Holley from Coltec Industries Inc, with plans to become an even larger and more aggressive company.

Immediately following the purchase, Holley set out to do just that, making several important and strategic acquisitions including Weiland, Lunati, Hooker, FlowTech/Airmass, Earl's and NOS. Annihilator ignition was also introduced.

The year 2003 marks the 100-year anniversary of the company that originally was incorporated as the Holley Brothers Company in 1903. It's been a long and exciting journey. The 100-year mark finds a Holley that is as strong and vibrant as ever. A Holley that is the leader of its industry and the largest and winningest automotive aftermarket performance company in the world. So where does Holley go from here? We'll continue to look to the future, developing quality performance products for the automotive, truck and marine markets.

Holley will always remain true to the rich heritage left behind by company founders George M. and Earl Holley. Truly, Holley is "The Heart and Soul of Performance".

George and Earl Holley would be proud of their 100 year legacy.



Tech Line: 270-781-9741

5

Technical Service

Holley Technical Service



Holley Technical Service offers the performance enthusiast an opportunity to talk to a factory-trained technician in the areas of:

- **Product Application & System Recommendations**
- **Specifications**
- **Troubleshooting**
- **Installation Tips**
- **Performance Tuning**

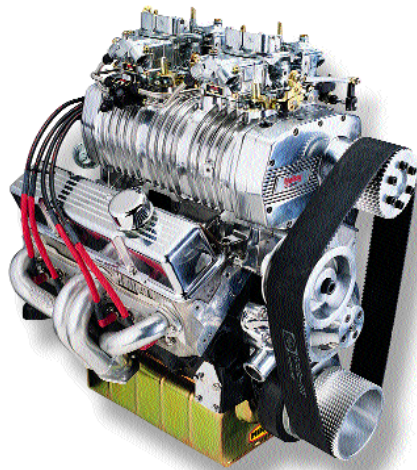

Visit

Holley's web site at: www.holley.com

Contact

Holley, Hooker, Weiland, Flowtech

Technical Service at:

Telephone 1-270-781-9741
FAX 1-270-781-9772

Earl's Technical Service at:

Telephone 1-310-609-1602
FAX 1-310-762-6719

NOS Technical Service at:

Telephone 1-714-546-0592
FAX 1-714-545-8319

E-Mail

help@support.holley.com
or
superchargers@support.holley.com
fuelpumps@support.holley.com
ignition@support.holley.com
flowtech@support.holley.com
hooker@support.holley.com
nosnitrous@support.holley.com
carbs@support.holley.com
fuelinjection@support.holley.com
lunati@support.holley.com

Write

Holley Performance Products
Technical Service
P.O. Box 10360
Bowling Green, KY 42102

6

www.holley.com

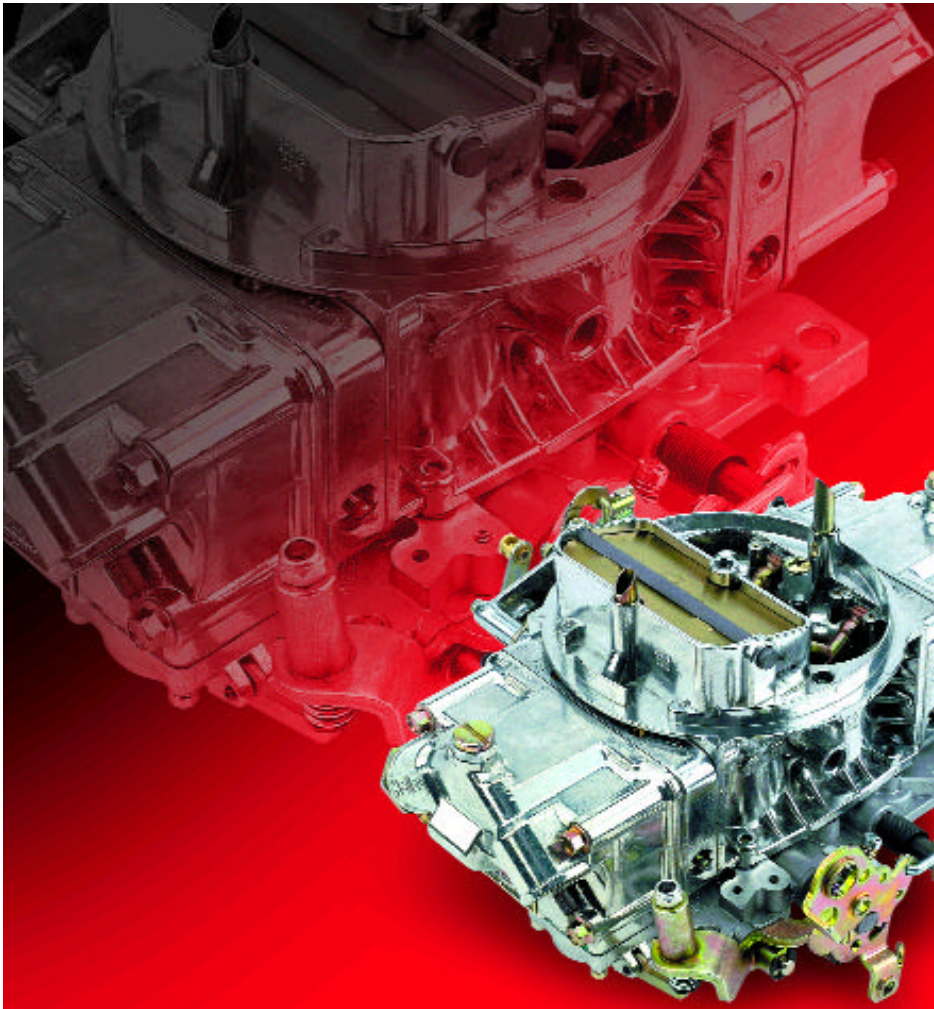

CARBURETORS

CARBURETORS

Section	Page #
Technical Information	8-18
Carburetor Quick Reference . . .	19
2 Bbl	20,21
4 Bbl	22-39
390 CFM.	22
570 CFM.	22
600 CFM.	23-26
650 CFM.	26,27
670 CFM.	27,28
700 CFM.	28
730 CFM.	28
750 CFM.	29-31
770 CFM.	31,32
800 CFM.	32

Section	Page #
830 CFM.	32,33
850 CFM.	33,34
870 CFM.	34
950 CFM.	35
1000 CFM	36
1050 CFM	36,37
1100 CFM	37
1150 CFM	37,38
1200 CFM	38
1250 CFM	39
Replacement Carbs.	40-42
O.E. Muscle Car Carbs	43
Service/Tuning Manuals	44,45
Service Parts and Accessories . .	46-92

Carburetors

CARBURETOR GENERAL INFORMATION

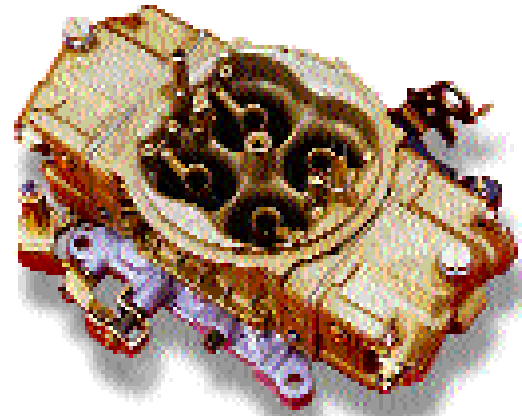
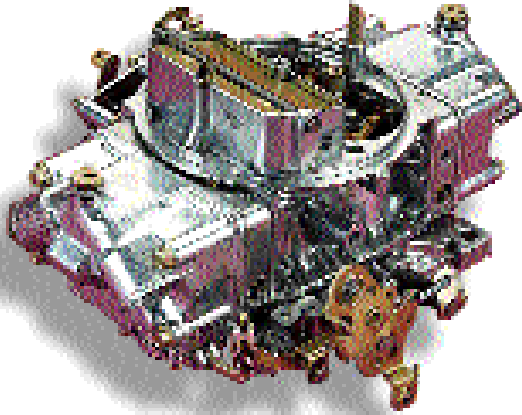

Which carburetor to choose? This question confronts anybody who is in the market for a carburetor, whether it is for the street, the drag strip or circle track. Holley offers a number of different carburetors that, looked at in total, may at first seem confusing. There is, however, a logical way to select the best carburetor for your particular needs.

The obvious first place to start is with the application or vehicle on which the carburetor will be installed. If the vehicle and engine is factory stock then simply turn to the "Street Legal Carburetor" section and find the listing for your particular application. Sometimes there will be a choice of either a square flange or spread bore flange carburetor. Either style will work in such cases, but the square flange carburetor will require the purchase of an adaptor to bolt it on to a spread bore flange manifold, and vice versa.

A high performance street or street/strip application is the next scenario to consider. In this case you will have to reference the carburetor listing (by CFM) section of the catalog. The first thing to consider here is the CFM or amount of air flow that the engine will require. There is a simple formula available that will put you right in the CFM ball park. The formula is:

Engine Size (CID) x Maximum RPM / 3456 = CFM @ 100% VE*
(Example: 350 CID x 6000 RPM = 2,100,000 / 3456 = 608 CFM)

Approximately 608 CFM would be required for this engine. However, most Street engines are capable of achieving only about 80% VE; a modified street engine with ported heads, headers, intake and carburetor can achieve about 85% VE; a fully modified race engine can achieve 95% or greater VE. The CFM number arrived at with this formula must be factored by this percentage.



Next, you need to decide whether a vacuum secondary or a mechanical secondary carburetor will work best for you.

As a rule of thumb, vacuum secondary carburetors work best on:

- Relatively heavy vehicles
- Street gearing
- Automatic transmission
- Engines built more for low-end torque

Conversely, mechanical secondary carburetors seem to work best on:

- Relatively light vehicles
- Strip gearing (4.11 or numerically higher)
- Manual transmission
- Engines built more for top-end horsepower

The type of choke would be the next decision to face. Most of the Holley universal performance carburetors come equipped with either a manual or automatic electric choke. Manual chokes can be converted over to automatic electric choke operation with the proper Holley kit, and vice versa.

Most automatic transmission kickdown linkage hookups will bolt directly to the carburetor throttle lever. Chrysler applications will require the purchase of bracket, P/N 20-7, if it's not already included with the carburetor. Those running the GM TH-700R4 automatic overdrive transmission will require the purchase of bracket, P/N 20-95, for this purpose.

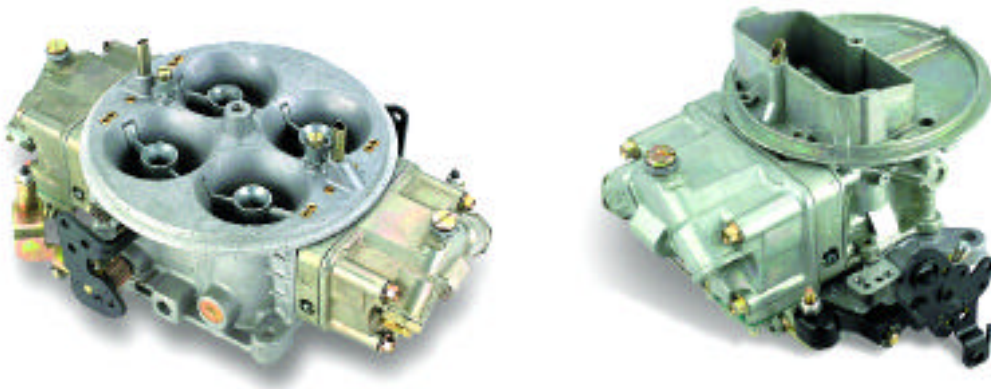

CHROMIUM
FUEL METERING
THROTTLE BODIES
FUEL PUMPS
INTAKE MANIFOLDS
SUPERSPINDERS
CYLINDER HEADS
SYMBAK
WATER PUMPS
DRESS-UP
BATTERY
STREET & TRUCK ADAPTERS
POINT-OF-SALE
INDEX/ABBREVIATION

Tech Line: 270-781-9741

Carburetors

How to Select the Right Carburetor Size

Volumetric Efficiency

Before you can determine the correct carburetor size for your engine, you must know its volumetric efficiency. Volumetric efficiency is an indicator of how well an engine can breathe. The better an engine's "breathing ability" the higher its volumetric efficiency. It is expressed as the ratio of the actual mass (weight) of air taken into the engine compared to the mass which the engine displacement would theoretically take in if there were no losses. The ratio is expressed as a percentage. It is quite low at idle and low speeds and varies with engine speed.

Volumetric efficiency should be computed at the expected operating RPM or your engine application.

Use the following examples as a guide to estimate the volumetric efficiency of your engine.

(A) An ordinary low-performance engine has a volumetric efficiency of about 80% at maximum torque.

(B) A high-performance engine has a volumetric efficiency of about 85% at maximum torque.

(C) An all-out racing engine has a volumetric efficiency of about 95% at maximum torque.

A highly tuned intake and exhaust system with efficient cylinder head porting and a camshaft ground to take full advantage of the engine's other equipment can provide such complete cylinder filling that a volumetric efficiency of 100%, or slightly higher, is obtained at the speed for which a system is tuned.

The graph below can be used to find your airflow requirement. It's based on 100% volumetric efficiency so any indicated airflow must be multiplied by the volumetric efficiency of your particular engine. Use a carburetor with an airflow rating equal to or slightly smaller than the air requirement of your engine.

Let's take for example, a 300 C.I.D. V-8 which has a maximum RPM limit of 8000 RPM. It's been determined that this particular engine has a volumetric efficiency of 85%. According to our chart the engine's airflow requirement is 700 C.F.M. at 100% volumetric efficiency. At 85%, however, the C.F.M. requirement is 595 C.F.M. This engine would, therefore, require a 600 C.F.M. carburetor.

NOTE: Supercharged engines generally require carburetors with 40% to 50% more C.F.M. than normally aspirated engines. Holley offers a new line of supercharger carburetors. These carbs are identified by this logo:

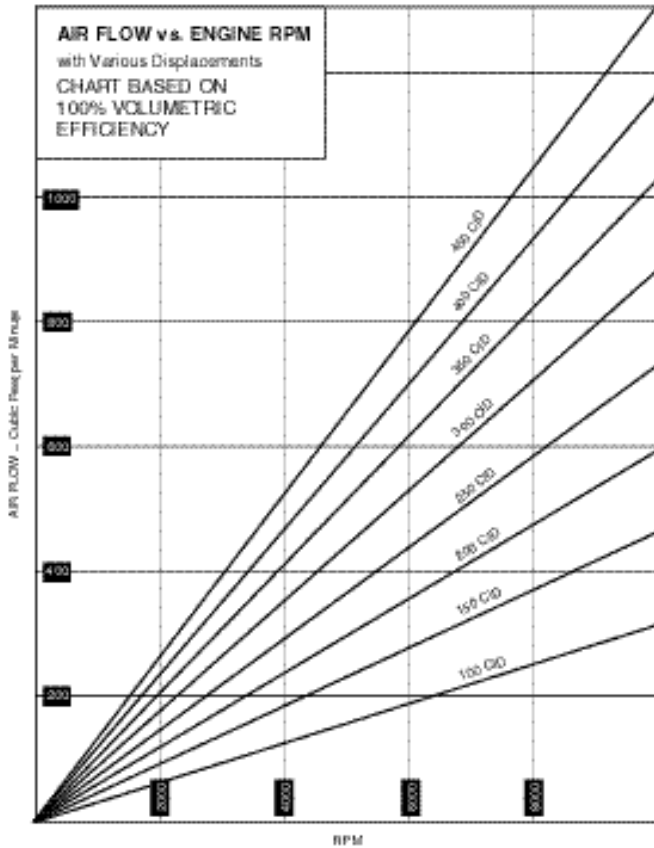

10

www.holley.com





Selecting a Mechanical Secondary Carburetor

For high performance engines a carburetor with mechanical secondaries has an inherent advantage over a carburetor with a "controlled" secondary system (air valve or vacuum diaphragm). This is possible because a controlled secondary carburetor, until it reaches wide open throttle, will not have as great a pressure drop below the throttle plates as would a mechanical secondary unit. The greater the pressure drop below the throttle plates the more dense will be the fuel/air charge to the engine and, hence, the more output.

Greater care, however, must be taken in selecting the correct size mechanical secondary carburetor for an application. Double pump, mechanical secondary carburetors initially depend only on the accelerator pumps to provide adequate fuel until enough air flow can be established to begin pulling in the main system. The larger the carburetor the higher the air flow required to accomplish this. If the carburetor is too large, the pump shot will be consumed before the main system starts. The result is a "bog" or a "sag".

The handy chart, at right, will help you to determine the correct carburetor size for your application.

Carburetor Size Selector*

For Model 4150 Double-Pumpers, Model 4165 Spread-Bore, Model 4500 Dominator

More about using the chart – If your car has an automatic-transmission, make sure you know the converter stall speed before using the chart. If in doubt, use the figure shown for a typical Chevrolet converter (1350 RPM). If you are using a modified converter for a racing application, make sure the stall speed is what you think it is. If your car has a manual transmission, use the lowest RPM at which you use

wide-open throttle. This must be a very conservative RPM (on the low-RPM side, that is!) and should be found by observing your own driving habits in the vehicle involved. Watch your tachometer! The heavier the vehicle and the lower the numerical axle ratio (higher gear ratio) – the lower this RPM must be.

With engines from 300 to 400 CID, the right choice usually works out to be a 650 to 700 CFM carburetor. A light car, such as a Camaro, Mustang or Duster may be able to use a 700 or

750 CFM unit, especially with a high numerical gear ratio (low gear ratio).

When in doubt, select a smaller carburetor size because it will typically give better acceleration times – even though power may fall off slightly at top RPM. You can believe that you'll be happier with the smaller carburetor nearly every time!

* From "Holley Carburetors & Manifolds" by Mike Ulrich and Bill Fisher

Airflow vs. Engine RPM

For Model 4150 Double-Pumpers, Model 4165 Spread-Bore, Model 4500 Dominator

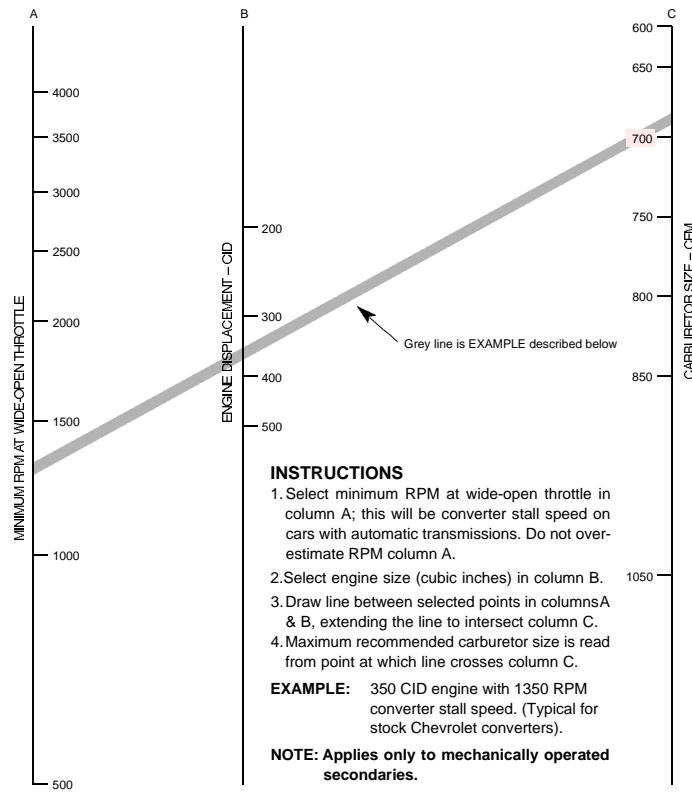

- CARBURETORS
- FUEL METERING
- THROTTLE BODIES
- FUEL PUMPS
- INTAKE MANIFOLDS
- SUPERCHARGERS
- CYLINDER HEADS
- SPARKPLUGS
- WATER PUMPS
- DRESS-UP
- BATTERY
- STREET & TRUCK ADAPTERS
- POINT-OF-SALE
- NEW/UPGRADES

Tech Line: 270-781-9741

Carburetors

Inside Your Holley Carburetor

The carburetor is quite simply a fuel metering device that operates under the logical and straightforward laws of physics. It has evolved over the years from a very simple and basic design to the complex and intricate models that are available today. A carburetor's functions can be easily analyzed and understood but at the same time it can be frustratingly difficult to troubleshoot problems associated with it. Many times a carburetor is looked at as the prime culprit or the main cause for a myriad of other engine-related difficulties that might exist. Therefore, it's best to check and verify the condition of the complete engine system before proceeding with any carburetor work.

There should be no vacuum leaks, the carburetor floats and the ignition timing should be properly set and the carburetor and engine should both be in sound mechanical condition. There's an old saying that "You can't beat a dead horse". Well, the same can be said about carburetors. Tuning the carburetor won't cure bad valves, leaky head gaskets, worn piston rings or cracked and leaking vacuum lines and, no matter how much time and effort you devote toward it, the results will be the same.

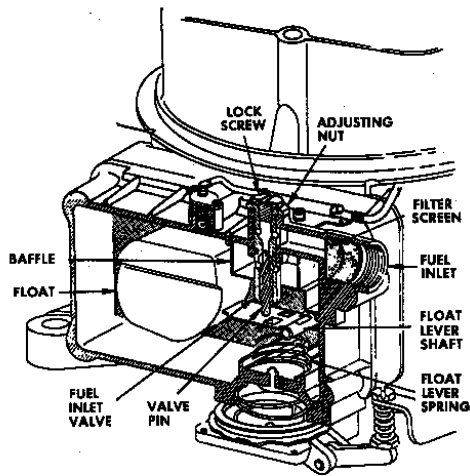

*Fuel Inlet System. Side Pivot/Hung Float.
Externally Adjustable Fuel Inlet Valve.*

Fuel Inlet System

The fuel inlet system consists of a fuel bowl, fuel inlet fitting, fuel inlet needle and seat, and a float assembly. A fuel inlet screen or filter is usually installed in the fuel inlet fitting. However, if there is no filter or screen in the fuel inlet fitting, an in-line filter must be installed to prevent dirt or other contaminants from entering the carburetor.

Holley performance carburetors are equipped with a fuel bowl that is designed either for a center pivot or a side pivot float. An externally adjustable needle and seat assembly is used so that the float level can be easily adjusted without the need to disassemble the carburetor.

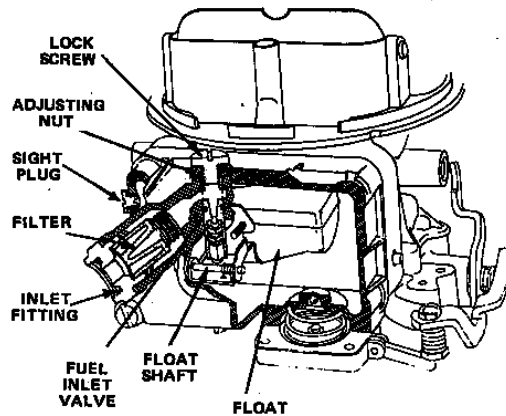

*Fuel Inlet System. Center Pivot/Hung Float.
Externally Adjustable Fuel Inlet Valve.*



Idle System

The idle system supplies the air/fuel mixture to operate the engine at idle and low speeds. Fuel enters the main well through the main metering jet that is screwed into the metering block. Some of this fuel is then bled off to an idle well where it is mixed with air from the idle air bleed hole. The idle well leads directly to the idle discharge port and the idle transfer system where this air/fuel mixture is discharged.

Most Holley Street Performance, O.E. Muscle Car, Competition and Pro-Series HP carburetors utilize idle mixture screws, located on the sides of the primary metering block. These control the volume of the pre-mixed air/fuel coming through the idle well. Turning the screws clockwise will "lean" the idle system. Conversely, turning the screws counterclockwise will "richen" the idle system.

The initial adjustment is made by turning the mixture screws in a clockwise direction until they lightly bottom. Back them both off 1-1/2 turns. Connect a vacuum gauge to a carburetor vacuum port that will have access to full manifold vacuum at idle. Start the engine and allow it to warm up. Once the engine has warmed up and the idle stabilized, the choke should be disengaged. Adjust the idle mixture screws to obtain the highest vacuum reading. Each screw should be turned an equal amount so that the system is balanced.

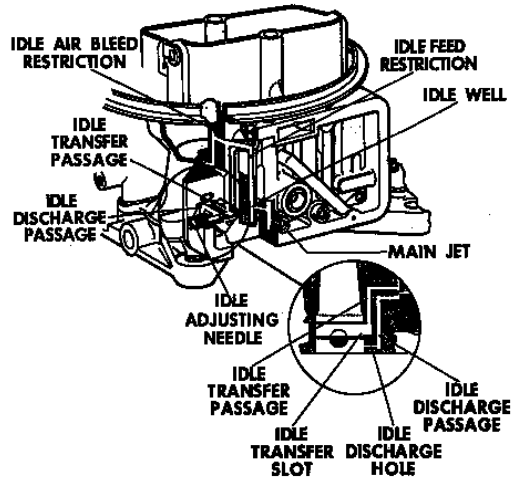
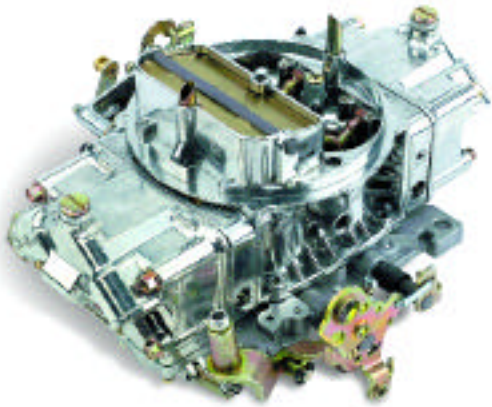

*Idle System.
Model 2300 — Primary Side 4V.*

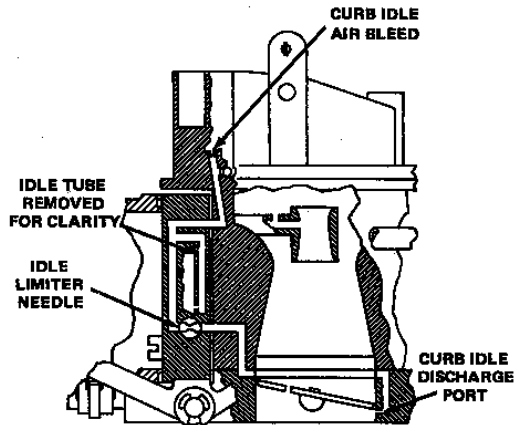

*Curb Idle System.
Primary Idle Transfer System.*

CARBURETORS

FUEL METERING

THROTTLE BODIES

FUEL PUMPS

INTAKE MANIFOLDS

SPRINGS

CYLINDER HEADS

SYSTEMS

WATER PUMPS

DRIFT-UP

BATTERY

STREET & TRUCK ADAPTERS

POINT-OF-SALE

INDEX/ VARIANTS

Tech Line: 270-781-9741

13

Carburetors

Main Metering System

The main metering system is designed to supply the leanest fuel mixture for cruising in the 35 MPH and over range. Operation is simple. Fuel from the main metering jet enters the main well and is mixed with air from the high speed air bleed. Engine vacuum pulls this air/fuel mixture and discharges it through the booster venturi and into the manifold through the throttle bores.

On a street vehicle optimum jetting can be determined by driving at various steady speeds and taking vacuum and spark plug readings. Manifold vacuum will increase the closer you get to ideal jetting; it will fall off once you get past this point. The ideal color for the spark plug porcelain is light brown or tan. A color lighter than this indicates that the carburetor is jetted lean; a darker color indicates that the carburetor is jetted rich.

Holley jets are number-stamped on their side for identification purposes. A higher relative number indicates a larger jet size. Changing to a larger or smaller jet will either richen or make leaner the carburetor's fuel curve from part throttle to full throttle, respectively.

NOTE: Jump two sizes when changing the carburetor jetting. There is approximately a 4-1/2% flow difference from one jet size to the next and one size won't make that much of a difference. If you must go up or down 8-10 jet sizes then you have a problem either with the fuel delivery system or the carburetor is wrong for the application.

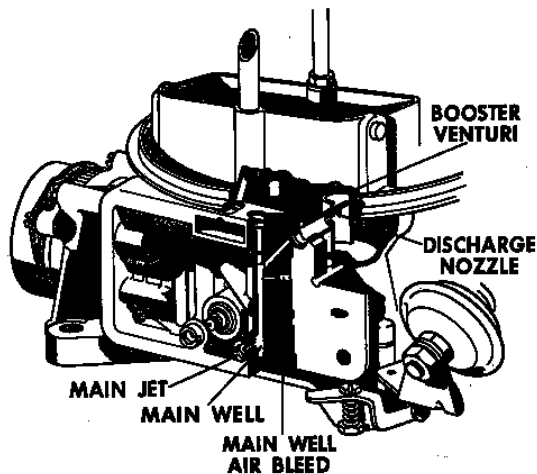

Main Metering System.

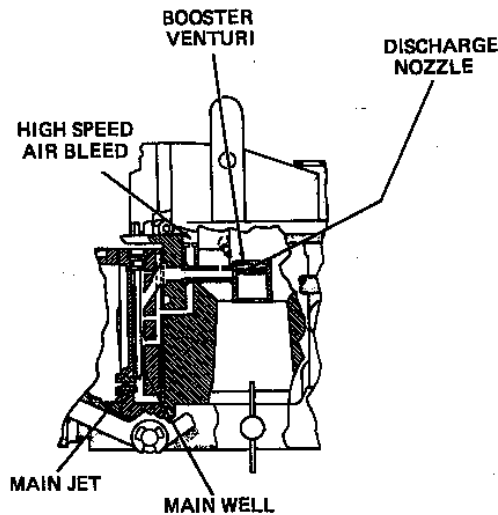

*Side View Main Metering System.
Showing Idle Tube in Main Well.*



Accelerator Pump System

The accelerator pump system consists of three main components: the pump diaphragm, the pump cam and the pump nozzle. This is the carburetor system that is most responsible for having good, crisp, off-idle throttle response. Its purpose is to inject a certain amount of fuel down the throttle bores when the throttle is opened. By accomplishing this purpose it acts to smooth the transition between the idle and main circuits so that no stumble, hesitation or sluggishness will be evident during this transition phase.

The first adjustment to check is the clearance between the pump operating lever and the pump diaphragm cover's arm, at wide open throttle. This clearance should be around .015". The purpose for this clearance is to assure that the pump diaphragm is never stretched to its maximum limit at wide open throttle. This will cause premature pump failure. Once this clearance has been set take a good look at the pump linkage and work the throttle. Make sure that the accelerator pump arm is being activated the moment that the throttle begins to move. This will assure that pump response will be instantaneous to the movement of the throttle. These adjustments can be made by turning the accelerator pump adjusting screw that is located on the accelerator pump arm together with the pump override spring and lock nut.

The amount of fuel that can be delivered by one accelerator pump stroke is determined by the pump's capacity and the profile of the pump cam. The period of time that it will take for this pre-determined amount of fuel to be delivered is affected by the pump nozzle size.

A larger pump nozzle will allow this fuel to be delivered much sooner than a smaller pump nozzle. If you need more pump shot sooner, then a larger pump nozzle size is required. During acceleration tests, if you notice that the car first hesitates and then picks up, it's a sure bet that the pump nozzle size should be increased. A backfire (lean condition) on acceleration also calls for a step up in pump nozzle size. Conversely, if off-idle acceleration does not feel crisp or clean, then the pump nozzle size may already be too large. In this case a smaller size is required.

Holley accelerator pump nozzles are stamped with a number which indicates the drilled pump hole size. For example, a pump nozzle stamped "35" is drilled .035". Pump nozzle sizes are available from .025" to .052". Please note that whenever a .040" or larger accelerator pump nozzle is installed the "hollow" pump nozzle screw should also be used. This screw will allow more fuel to flow to the pump nozzle, assuring that the pump nozzle itself will be the limiting restriction in the accelerator pump fuel supply system.

Accelerator Pump System.

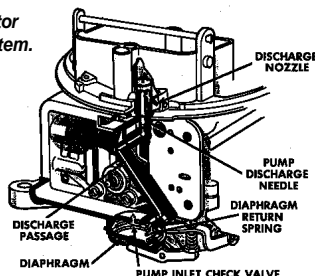

Figure 8—Accelerator Pump System with Plastic Inlet Check Valve.

NOTE: When changing the pump nozzle it's best to jump three sizes. For example if there's currently an off-line hesitation with #28 (.028") pump nozzle, try a #31 (.031") pump nozzle. If you must use a #37 (.037") or larger pump nozzle, then also use a 50cc pump.

The same applies to the accelerator pump cams. Once a pump nozzle size selection has been made the accelerator pump system can be further tailored with the pump cam. Holley offers an assortment of different pump cams, each with uniquely different lift and duration profiles, that are available under Holley P/N 20-12. Switching cams will directly affect the movement of the accelerator pump lever and, subsequently, the amount of fuel available at the pump nozzle. Lay out the pump cams side by side and note the profile differences. This little exercise may help to better explain the differences between the cams and their effect on pump action.

Installing a pump cam is straightforward. It's a simple matter of loosening one screw, placing the new pump cam next to the throttle lever and tightening it up. There are two and sometimes three holes in each pump cam, numbered 1, 2 and 3. Placing the screw in position #1 activates the accelerator pump a little early, allowing full use of the pump's capacity. Generally, vehicles which normally run at lower idle speeds (600 or 700 RPM) find this position more useful because they can have a good pump shot available coming right off this relatively low idle. Positions #2 and #3 delay the pump action, relatively speaking. These two cam positions are good for engines that idle around 1000 RPM and above. Repositioning the cam in this way makes allowance for the extra throttle rotation required to maintain the relatively higher idle setting. Pump arm adjustment and clearance should be checked and verified each and every time the pump cam and/or pump cam position is changed.

Lastly, a 50cc accelerator pump conversion kit is available under Holley P/N 20-11 when maximum pump capacity is desired.

CHARACTERISTICS

FUEL METERING

THROTTLE BODIES

FUEL PUMPS

INTAKE MANIFOLDS

SUPERCHARGERS

CYLINDER HEADS

SYSTEMS

WATER PUMPS

DRESS-UP

BATTERY

STREET & TRUCK ADAPTERS

POINT-OF-SALE

INDEX/ VARIANTS

Tech Line: 270-781-9741

15

Carburetors

Power Enrichment System

The power enrichment system supplies additional fuel to the main system during heavy load or full power situations. Holley carburetors utilize a vacuum operated power enrichment system and a selection of power valves is available to "time" this system's operation to your specific needs. Each Holley power valve is stamped with a number to indicate the vacuum opening point. For example, the number "65" indicates that the power valve will open when the engine vacuum drops to 6.5" or below. An accurate vacuum gauge, such as Holley P/N 26-501, should be used when determining the correct power valve to use. A competition or race engine which has a long duration high overlap camshaft will have low manifold vacuum at idle speeds. If the vehicle has a manual transmission, take the vacuum reading with the engine thoroughly warmed up and at idle. If the vehicle is equipped with an automatic transmission, take the vacuum reading with the engine thoroughly warmed up and idling in gear. In either case, the power valve selected should have a vacuum opening point about 2" Hg below the intake manifold vacuum reading taken.

A stock engine, or one that is only mildly built for street use, will have high manifold vacuum at idle speeds. To determine the correct power valve the vehicle should be driven at various steady speeds and vacuum readings taken. The power valve selected should have an opening point about 2" Hg below the lowest steady speed engine vacuum observed.

Most of the popular Holley "Street Legal" and "Street Performance" carburetors incorporate a power valve blow-out protection system. A special check valve is located in the throttle body expressly for this purpose. This check valve is designed to be normally open but will quickly seat to close off the internal vacuum passage when a backfire occurs. Once closed, the check valve interrupts the pressure wave caused by the backfire, thus protecting the power valve.

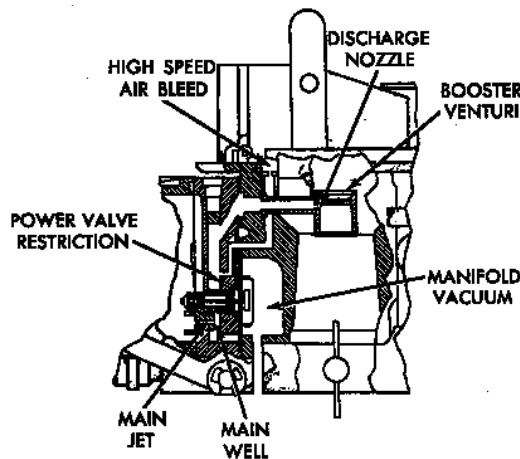

Power Enrichment System.

The Truth About Powervalves used with Holley Carburetors

There still seems to be a lot of misconception about Holley carburetors blowing power valves. Nothing could be further from the truth. Holley performance carburetors built since 1992 have utilized a power valve check system that effectively eliminated this infrequent problem. Consisting of a spring, brass seat and check ball, the check ball system is 100% effective protecting the power valve diaphragm from damage due to engine backfire.

The power valve check ball is designed to be normally open but quickly seals to close off the internal vacuum passage when a backfire occurs. Once closed, the check valve interrupts the pressure wave generated by the backfire, thus protecting the power valve diaphragm. There is no way that the power valve's diaphragm can rupture due to an engine backfire!



Choke System

The choke system is designed to supply a rich fuel mixture to the engine for cold starts and cold drive-away conditions.

Holley carburetors with chokes will come equipped with either a manual, electric or hot air choke. All Holley square flange carburetors originally equipped with either a manual or hot air choke can be converted to automatic electric choke operation with the proper kit. Conversely, those equipped with either an electric or hot air choke can be converted to manual choke operation with the proper kit.

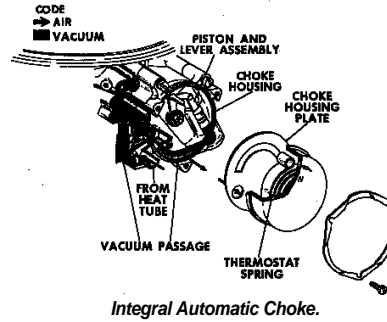

Secondary System

The secondary system of a Holley four barrel carburetor can be either vacuum or mechanically operated.

The opening rate of a mechanical secondary system is pre-determined by the linkage which is usually designed to allow the secondary throttle plates to begin opening once the primary throttle plates have rotated open about 40 degrees. Special Holley kits are also available which will allow the conversion to 1:1 linkage (primary and secondary throttle plates opening simultaneously) for special racing applications.

The opening rate of a vacuum secondary system is controlled by the diaphragm spring located in the vacuum secondary diaphragm housing. A "lighter" spring will allow the secondary throttle plates to open more quickly. A spring assortment kit, Holley P/N 20-13, is available to help you "tailor" the secondary opening rate to your application. A "quick change" kit, Holley P/N 20-59, is also available for fast and easy access to the spring. It consists of a two-piece secondary diaphragm housing cover which, after it's installed, can easily cut in half the time required to change the secondary spring.

DO NOT put a screw in the linkage of a vacuum secondary carburetor to mechanically "force" open the secondary throttle plates. Normally there is an accelerator pump on the secondary side of a mechanical secondary carburetor. The purpose of the secondary pump is to inject additional fuel to "cover" the transition time up to the point when the secondary main system starts to flow. Without this secondary pump shot the engine will go to an instant lean condition. Therefore, forcing the secondaries to open prematurely will hinder performance and may cause an engine backfire. The screw could also create a bind and cause the throttle to stick open.

Vacuum Operated Secondary System.

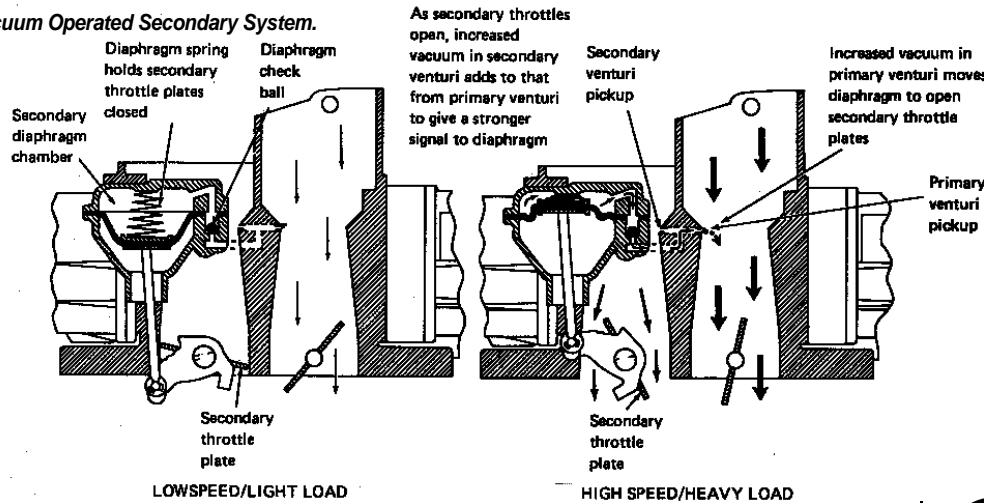

CRACKERS
FUEL METERING
THROTTLE BODIES
FUEL PUMPS
INTAKE MANIFOLDS
SPEEDCHAMBERS
CYLINDER HEADS
SPARKS
WATER PUMPS
DRESS-UP
BATTERY
STREET & TRUCK ADAPTERS
POINT-OF-SALE
INDEX/VEHICULAR

Tech Line: 270-781-9741

Carburetors

General Guidelines For Adjusting Brass And Nitrophyl Floats

Two methods of float adjustment are provided for with Holley performance carburetors depending on the style of float bowl and needle and seat assembly employed. They are the internal (dry) setting and the external (wet) setting. The internal float adjustment is accomplished with the fuel bowl off the carburetor. With "internally adjustable" needle and seats, the fuel bowl is inverted and the float tang, or tab, is adjusted to the point where the float surface is parallel to the fuel bowl surface, just underneath. An initial dry setting can also be accomplished with "externally adjustable" needle and seats. To achieve this, invert the fuel bowl and turn the adjusting nut until the float surface lies parallel to the fuel bowl casting surface underneath.

Another, more accurate adjustment can be made with the side hung style float if measuring gauges, such as drill bits, are available. Here, with the fuel bowl inverted, the primary float can be adjusted to the point where there is a 7/64" gap between the "toe" of the float and the bottom of the fuel bowl surface underneath. The float "toe" is the part of the float furthest from where the arm is attached. The secondary float can be adjusted to the point where there is a 13/64" gap between the "heel" of the float and the bottom of the fuel bowl surface underneath. The float "heel" is the part of the float closest to the point where the arm is attached.

A "wet" level float adjustment can be performed on either the side or center hung floats, if the fuel bowls have provision for the externally adjustable needle and seats. This adjustment is made as follows. Start the vehicle up and move it out of the garage and into an open area where plenty of fresh ventilation is available. Allow the idle to stabilize. Turn the engine off and remove the sight plug from the primary fuel bowl to inspect the fuel level. If it's been determined that adjustment is required use a large screw driver to crack loose the lock screw. With a 5/8" open-end wrench turn the adjusting nut clockwise to lower the float level.

Conversely, turn the adjusting nut counter-clockwise to raise the float level. Tighten the lock screw. Restart the vehicle and let the engine idle stabilize. Shut the engine off. Remove the sight plug to reinspect the fuel level. The fuel level should stabilize at just below the level of the fuel bowl sight plug hole. This same adjustment procedure is performed on the secondary bowl.

NOTE: The float adjustment feature on Holley carburetors cannot cure a poor running engine, a bad ignition system, a clogged fuel filter, an improperly operating fuel pump or fuel pressure that is too high or low. This adjustment is provided solely to ensure that the fuel in the bowl can be adjusted to the correct level for the carburetor to perform its function. There is no need to "wrench" excessively on the adjustment nut. A quarter of a turn one way or the other should be enough to bring you into spec.

General Guidelines For Adjusting Duracon (Plastic) Floats

The Duracon float rides higher on the fuel than either the brass or nitrophyl float and, therefore, a higher setting is in order. A Duracon float, set at the same level as either a brass or nitrophyl float, would make the carburetor run leaner, everything else being equal. This is because there would be less fuel available in the fuel bowl. The Duracon float setting must be higher to compensate for this condition.

Dry Setting for Duracon Center Hung Float:

The primary side setting is .3125" (5/16"), measured with the fuel bowl inverted, at the middle of the float. The secondary side setting is .3750" (3/8"), measured with the fuel bowl inverted, at the middle of the float (back side).

Dry Setting for Duracon Side Hung Float:

The primary side setting is .2188" (7/32"), measured with the fuel bowl inverted, at the toe of the float. The secondary side setting is .3125" (5/16"), measured with the fuel bowl inverted, at the toe of the float.

Wet Setting for Duracon Float:

Refer to "Wet Float Setting", discussed previously.

WARNING: Caution should be exercised when doing the wet level float adjustment. Fuel at the needle and seat is under pressure from the fuel pump. Some may leak out when the adjustment is made and shop rags should be available to immediately wipe up any fuel spillage. Gasoline is flammable and proper precaution should be taken.

CAUTION: Once again, remember that these are general guidelines for adjusting floats. Your particular application may require additional fine tuning over and above these listed procedures.

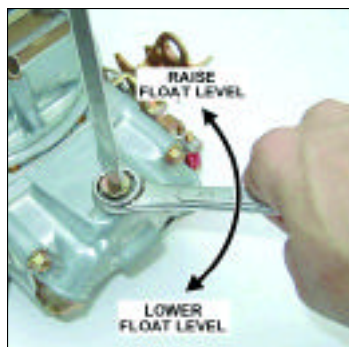



Performance Carburetor Quick Reference

Carburetor	CFM	Model	Secondaries	Style	Application					Choke	Page
					Street	Street/Strip	Race	Off Road	Supercharger		
0-80787-1	350	2300HP	N/A	Keith Dorton Circle Track			X			None	20
0-80583-1	500	2300HP	N/A	Keith Dorton Circle Track			X			None	20
0-4412C	500	2300	N/A	Universal	X					Manual	20
0-4412S	500	2300	N/A	Universal	X					Manual	20
0-8007	390	4160	Vacuum	Universal	X					Electric	22
0-80507-1	390	4150HP	Mechanical	Straight-Leg Boosters			X			None	22
0-80507-2	390	4150HP	Mechanical	Keith Dorton Circle Track			X			None	22
0-80570	570	4150	Vacuum	Street Avenger	X	X				Electric	22
0-80457S	600	4160	Vacuum	Universal	X	X				Electric	23
0-1850C	600	4160	Vacuum	Universal	X	X				Manual	23
0-1850S	600	4160	Vacuum	Universal	X	X				Manual	23
0-4776C	600	4150	Mechanical	Universal		X				Manual	23
0-80575	600	4150HP	Mechanical	Supercharger			X		X	None	23
0-80592S	600	4150	Mechanical	Supercharger	X	X			X	Manual	24
0-80540-1	600	4150HP	Mechanical	Straight-Leg Boosters			X			None	24
0-80783C	650	4150	Vacuum	Universal	X	X				Electric	26
0-80555C	650	4175	Vacuum	Spread Bore	X					Electric	26
0-4777C	650	1450	Mechanical	Universal		X				Manual	26
0-80541-1	650	4150HP	Mechanical	Straight-Leg Boosters			X			None	27
0-4224	660	4160	Mechanical (1:1)	Center-Squirter		X	X			None	27
0-80670	670	4150	Vacuum	Street Avenger	X	X				Electric	27
0-90670	670	4150	Vacuum	Truck Avenger	X			X		Electric	28
0-4778C	700	4150	Mechanical	Universal	X	X				Manual	28
0-80572S	700	4150	Mechanical	Supercharger	X	X			X	Manual	28
0-4609-1	730	4150	Vacuum	NHRA legal			X			None	28
0-80508S	750	4160	Vacuum	Universal	X	X				Electric	29
0-3310C	750	4160	Vacuum	Universal	X	X				Manual	29
0-3310S	750	4160	Vacuum	Universal	X	X				Manual	29
0-4779C	750	4150	Mechanical	Universal		X				Manual	29
0-80186-1	750	Dominator	Mechanical	2-Circuit		X	X			None	29
0-80573S	750	4150	Mechanical	Supercharger	X	X			X	Manual	30
0-80576	750	4150HP	Mechanical	Supercharger			X		X	None	30
0-80529-1	750	4150HP	Vacuum	Down-Leg Boosters		X	X			None	30
0-9379	750	4150	Mechanical	Universal		X	X			None	30
0-80528-1	750	4150HP	Mechanical	Down-Leg Boosters			X			None	31
0-80535-1	750	4150HP	Mechanical	Methanol			X			None	31
0-80770	770	4150	Vacuum	Street Avenger	X	X				Electric	31
0-90770	770	4150	Vacuum	Truck Avenger	X			X		Electric	31
0-4780C	800	4150	Mechanical	Universal		X				Manual	32
0-80574S	800	4150	Mechanical	Supercharger	X	X			X	Manual	32
0-80785	830	4150HP	Mechanical	Keith Dorton Circle Track			X			None	32
0-80509-1	830	4150HP	Mechanical	Down-Leg Boosters			X			None	33
0-80511-1	830	4150HP	Mechanical	Annular Boosters			X			None	33
0-9381	830	4150	Mechanical	Universal			X			None	33
0-4781C	850	4150	Mechanical	Universal		X				Manual	33
0-80531	850	4150	Vacuum	Universal	X	X				Electric	34
0-9380	850	4150	Mechanical	Universal			X			None	34
0-80870	870	4150	Vacuum	Street Avenger	X	X				Electric	34
0-80496-1	950	4150HP	Mechanical	Down-Leg Boosters			X			None	35
0-80498-1	950	4150HP	Mechanical	Methanol			X			None	35
0-80577	950	4150HP	Mechanical	Supercharger			X		X	None	35
0-80513-1	1000	4150HP	Mechanical	Down-Leg Boosters			X			None	36
0-80514-1	1000	4150HP	Mechanical	Annular Boosters			X			None	36
0-8082-1	1050	Dominator	Mechanical	2-Circuit			X			None	36
0-8896-1	1050	Dominator	Mechanical	3-Circuit			X			None	36
0-80586	1050	Dominator	Mechanical	Methanol			X			None	37
0-9375-1	1050	Dominator	Mechanical	3-Circuit			X			None	37
0-7320-1	1150	Dominator	Mechanical	2-Circuit			X			None	37
0-80556-1	1150	Dominator	Mechanical	3-Circuit			X			None	38
0-9377-1	1150	Dominator	Mechanical	3-Circuit			X			None	38
0-80532-1	1250	Dominator	Mechanical	3-Circuit			X			None	39
0-80533-1	1250	Dominator	Mechanical	3-Circuit			X			None	39

- CARBURETORS
- FUEL METERING
- THROTTLE BODIES
- FUEL PUMPS
- INTAKE MANIFOLDS
- SUPERCHARGERS
- CYLINDER HEADS
- SYSTEMS
- WATER PUMPS
- DRESS-UP
- BATTERY
- STREET & TRUCK AERIALS
- POINTS-TO-SELL
- INDEX/ABBREVIATION

Tech Line: 270-781-9741

Carburetors

Holley is proud to announce the Keith Dorton Signature carburetor series

Throughout this carburetor section, there are certain carburetors identified with a unique logo signifying them as being a Keith Dorton Signature Series carburetor. Keith Dorton is a world-renowned circle track engine builder who is noted for the extraordinarily successful engines that his company builds, including NASCAR winners. He's also deeply involved in many R & D projects for many of the major original equipment companies. Keith builds extraordinarily successful engines because he thoroughly understands the intricacies of engines and fuel systems; he's careful, methodical and devotes the necessary time and effort to do a job right the first time. For this reason he was approached by Holley to help develop a family of two and four-barrel racing carburetors that would have no peers.



The Keith Dorton Signature Series is no ordinary line of race carburetors. These carburetors were planned in detail from the outset. Then they were carefully developed, dyno-tested and track-tested by Keith Dorton and Holley to be the epitome of circle track racing carburetors. Relying on his years of hands-on experience and technical expertise, Keith Dorton has accomplished his task in admirable fashion. Race ready out of the box, Keith's carburetors are designed for bolt-on-and-win performance. The first two of Keith's Signature Series carburetors are listed below. Others are listed in their appropriate CFM category.



350 CFM Two Barrel

Part # **0-80787-1**^(B)

Features

- Keith Dorton Model 2300HP
- Intended for short circle track racing
- Eligible for NASCAR use
- All choke hardware removed
- 30cc accelerator pump w/ "anti-pullover" nozzle
- Power valve blow out protection
- HP-style metering block
- Screw-in air bleeds
- Stainless steel throttle plates
- 100% wet-flow tested and calibrated
- Many other special "race" features



500 CFM Two Barrel

Part # **0-80583-1**^(B)

Features

- Keith Dorton Model 2300HP
- Intended for short circle track racing
- Eligible for NASCAR use
- All choke hardware removed
- 30cc "off-the-corner" accelerator pump
- Power valve blow-out protection
- HP-style metering block
- Screw-in air bleeds
- Stainless steel throttle plates
- 100% wet-flow tested and calibrated
- Many other special "race" features

(A) Not legal for street use in California on vehicles originally equipped with 2-barrel carburetors for which there was no 4-barrel option.

(B) Not legal for sale or use in California on any pollution controlled motor vehicles.

or See page 2 for symbol explanation.



Keith Dorton 2300 HP Carburetor Features

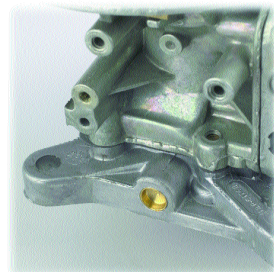
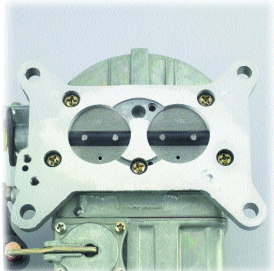
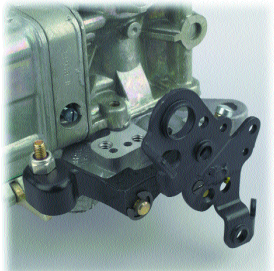
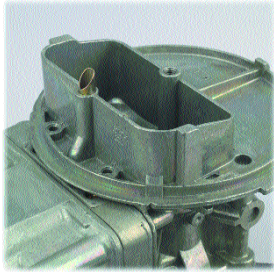

- Intended for short circle track racing
- Choke hardware and related machining provisions are deleted for smoother air flow
- Choke rod hole in main body is factory-sealed with a brass block-off plate to prevent unfiltered air from entering the carburetor.
- PCV and other external vacuum tube sources are deleted.
- "Straight-type" accelerator pump nozzle design is used to prevent any possibility of fuel pullover and to reduce any chance of rich conditions at high RPM.
- A plastic accelerator pump arm is used for more consistent operation.
- 30cc accelerator pump GFLT diaphragm is used for durability.
- 50cc accelerator pump system has been eliminated from the 500 CFM carburetor. It's been replaced with a user-friendly "off-the-corner" 30cc accelerator pump system.
- Power valve blow-out protection eliminates blown power valves.
- Welded throttle lever and shaft assembly is used for strength.
- Throttle plate screws are a low-profile buttonhead design, secured with Loctite®
- Screw-in type air bleeds are used to facilitate tuning.
- HP metering blocks are reinforced for strength and specially designed for optimum fuel atomization.
- Metering blocks have installed fuel slosh/vent baffles for superior fuel control during hard acceleration and braking conditions.
- Fuel bowl screw gaskets are made of nylon, so they're reusable.
- Stainless steel throttle plates are used with drilled air bypass hole(s) for smooth idle.
- A metal cup plug is installed in the throttle body shaft opening, opposite the throttle shaft lever, to eliminate dust, contaminants and unapproved air flow from entering the carburetor.
- Air cleaner mounting stud increased from 1/4" to 5/16" diameter for added strength and dependability (500 CFM carburetor).
- Sizes of throttle bore, venturi, booster diameter, throttle plate thickness and throttle shaft diameter have not changed. They comply and are fully consistent with the technical gauging now in use. Venturi casting rings are reamed to legal dimensions, for more consistent air flow.
- ID numbers for carburetor and metering block are relocated for ease of viewing.
- Factory flow-tested to insure quality and reliability.

NOTE: Eligible for NASCAR® use beginning with the 2001 competition season.

(A) Not legal for street use in California on vehicles originally equipped with 2-barrel carburetors for which there was no 4-barrel option.

(B) Not legal for sale or use in California on any pollution controlled motor vehicles.

◆ ◆ or ◆ See page 2 for symbol explanation.

CARBURETORS
FUEL METERING
THROTTLE BODIES
FUEL PUMPS
INTAKE MANIFOLDS
SUPERCHARGERS
CYLINDER HEADS
SYSTEMS
WATER PUMPS
DRESS-UP
BATTERY
STREET & TRUCK ADAPTERS
PUMP-UP-SALE
HONEY/VEHICULAR

Tech Line: 270-781-9741

Carburetors

STREET



500 CFM Two Barrel

0-4412C^(B) 3

Part # 0-4412S^(B) 3

Features

- Model 2300 w/ center hung float
- Manual choke
- Ford A/Tkickdown
- Power valve blow-out protection
- 50cc accelerator pump
- Does not work with A.O.D. transmissions
- 100% wet-flow tested and calibrated

NOTE: 0-4412C has classic finish, 0-4412S has shiny finish

OPTIONAL PARTS & KITS

P/N	DESCRIPTION
20-7	Chrysler throttle lever extension
20-62	Throttle shaft kit
45-224	Electric choke kit (requires 45-465 dechoke kit)
45-465	Dechoke linkage for 45-224 kit
45-228	Manual choke control cable

STREET



390 CFM Four Barrel

Part # 0-8007^(B) 3

Features

- Model 4160 w/ side-hung floats
- Small V-8 or 6 cyl. engines
- 2x4 street tunnel rams
- Electric choke
- Ford A/Tkickdown
- Power valve blow-out protection
- Vacuum secondaries
- 100% wet-flow tested and calibrated

OPTIONAL PARTS & KITS

P/N	DESCRIPTION
20-59	Quick change secondary spring kit
20-88	Throttle cable/return spring bracket kit
34-2	Center hung float bowl kit
34-6	Secondary metering block
20-95	GM A.O.D. transmission bracket kit
17-6	Spread bore manifold adapter

RACE



390 CFM Four Barrel

Part # 0-80507-1^(B) 3

Features

- Model 4150 HP w/ center hung floats
- NASCAR approved
- Progressive mechanical secondaries
- Double 30cc accelerator pumps
- Four corner idle system
- Stainless steel throttle plates w/ buttonhead screws
- Screw-in/replaceable air bleeds available
- Power valve blow-out protection
- Non-stick gaskets
- 100% wet-flow tested and calibrated

RACE READY OUT OF THE BOX



570 CFM Four Barrel

Part # 0-80570^(B) 3

Features

- Model 4150 w/ center hung floats
- Electric choke
- Quick-change vacuum secondary
- Ford A/Tkickdown
- Power valve blow-out protection
- 4 Vacuum ports (PCV, power brake, spark, accessories)
- Lifetime limited warranty
- 100% wet-flow tested and street calibrated

(A) Not legal for street use in California on vehicles originally equipped with 2-barrel carburetors for which there was no 4-barrel option.

(B) Not legal for sale or use in California on any pollution controlled motor vehicles.

1 2 or 3 See page 2 for symbol explanation.



STREET

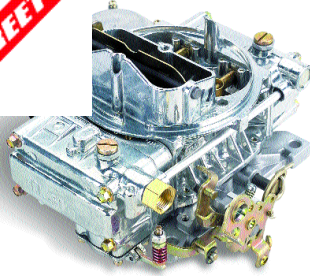

600 CFM Four Barrel

Part # **0-80457S**^(A)

Features

- Model 4160 w/ side hung floats
- Calibrated for excellent street performance
- Electric choke
- Ford A/Tkickdown
- Vacuum secondaries
- Power valve blow-out protection
- Vacuum ports:
 - 2 full manifold, 1 timed vacuum
- Includes (banjo) fuel inlet fitting
- 100% wet-flow tested and street calibrated

OPTIONAL PARTS & KITS

P/N	DESCRIPTION
20-59	Quick change secondary spring kit
20-88	Throttle cable/return spring bracket kit
34-2	Center hung float bowl kit
34-6S	Secondary metering block (shiny)
20-95	GM A.O.D. transmission bracket kit
17-6	Spread bore manifold adapter

0-1850C^(B)

Part # **0-1850S**^(B)

STREET/STRIP



600 CFM Four Barrel

Features

- Model 4160 w/ side hung floats
- Calibrated for excellent street performance
- Manual choke
- Power valve blow-out protection
- Vacuum secondaries
- 100% wet-flow tested and calibrated

OPTIONAL PARTS & KITS

P/N	DESCRIPTION
20-59	Quick change secondary spring kit
20-88	Throttle cable/return spring bracket kit
34-2	Center hung float bowl kit
34-6	Secondary metering block
45-223	Electric choke kit
20-95	GM A.O.D. transmission bracket kit
17-6	Spread bore manifold adapter

NOTE: 0-1850C has classic finish, 0-1850S has shiny finish

STREET/STRIP



600 CFM Four Barrel

Part # **0-4776C**^(B)

Features

- Model 4150
- Unique shiny / chromate dip finish
- Double pump
- Mechanical secondaries
- Center hung float bowls
- Manual choke
- Power valve blow-out protection
- 100% wet-flow tested and calibrated

OPTIONAL PARTS & KITS

P/N	DESCRIPTION
20-88	Throttle cable/return spring bracket kit
34-150	Chrome fuel line
45-224	Electric choke kit
45-228	Manual choke control cable
17-6	Spread bore manifold adapter

RACE



600 CFM Four Barrel

Part # **0-8057S**^(B)

Features

- Model 4150 HP design
- Chevrolet small block 2x4, 671 blower calibration
- Four-corner idle system
- Dual 50cc accelerator pumps
- Replaceable air bleeds
- Manifold-referenced power valve
- 100% wet-flow tested and calibrated

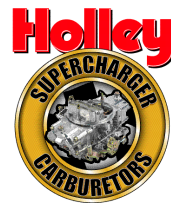

(A) Not legal for street use in California on vehicles originally equipped with 2-barrel carburetors for which there was no 4-barrel option.

(B) Not legal for sale or use in California on any pollution controlled motor vehicles.

or See page 2 for symbol explanation.

CARBURETORS
FUEL METERS
THROTTLE BODIES
FUEL PUMPS
INTAKE MANIFOLDS
SUPERCHARGERS
CYLINDER HEADS
SYSTEMS
WATER PUMPS
DRESS-UP
BATTERY
STREET & TRUCK ADAPTERS
POINT-OF-SALE
MAINTENANCE/REPAIR

Tech Line: 270-781-9741

Carburetors

STREET/STRIP

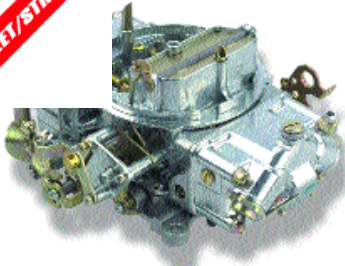

600 CFM Four Barrel

Part # **0-80592S^(B)**

Features

- Designed for use with superchargers
- Model 4150 with shiny finish
- Mechanical progressive linkage
- Dual 50cc accelerator pumps
- Manifold-referenced power valve
- Manual choke
- 100% wet-flow tested and calibrated

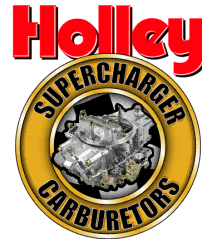

RACE

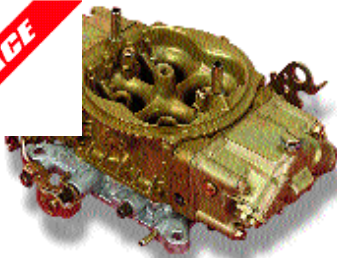

600 CFM Four Barrel

Part # **0-80540-1^(B)**

Features

- Model 4150 HP design
- Straight-leg boosters
- Calibrated for gasoline
- Double 30cc accelerator pumps
- Progressive mechanical secondaries
- Four-corner idle system
- Power valve blow-out protection
- Screw-in air bleeds
- Non-stick gaskets
- Notched secondary float w/ jet extensions
- 100% wet-flow tested and calibrated

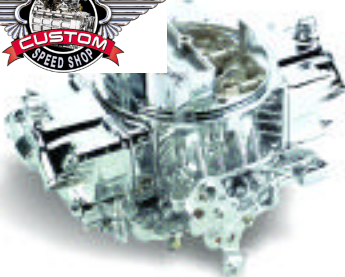

600 CFM Four Barrel

Part # **60-600^(B)**

Features

- Model 4160 w/ center hung floats
- Chrome finish / Chrome fuel line
- Electric choke
- Ford A/Tkickdown
- Vacuum secondaries
- Power valve blow-out protection
- Vacuum ports:
2 full manifold, 1 timed vacuum
- 100% wet-flow tested and street calibrated

OPTIONAL PARTS & KITS

P/N	DESCRIPTION
20-59	Quick change secondary spring kit
20-88	Throttle cable/return spring bracket kit
20-95	GM A.O.D. transmission bracket kit
17-6	Spread bore manifold adapter

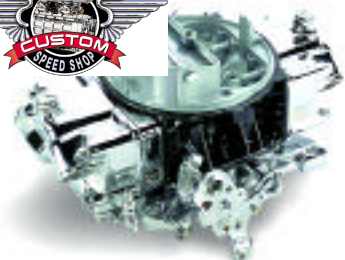

600 CFM Four Barrel

Part # **60-601^(B)**

Features

- Model 4160 w/ center hung floats
- Chrome & Black / Chrome fuel line
- Electric choke
- Ford A/Tkickdown
- Vacuum secondaries
- Power valve blow-out protection
- Vacuum ports:
2 full manifold, 1 timed vacuum
- 100% wet-flow tested and street calibrated

OPTIONAL PARTS & KITS

P/N	DESCRIPTION
20-59	Quick change secondary spring kit
20-88	Throttle cable/return spring bracket kit
20-95	GM A.O.D. transmission bracket kit
17-6	Spread bore manifold adapter

(A) Not legal for street use in California on vehicles originally equipped with 2-barrel carburetors for which there was no 4-barrel option.

(B) Not legal for sale or use in California on any pollution controlled motor vehicles.

or See page 2 for symbol explanation.



600 CFM Four Barrel

Part # **60-602^(B)**

Features

- Model 4160 w/ center hung floats
- Chrome & Red / Chrome fuel line
- Electric choke
- Ford A/Tkickdown
- Vacuum secondaries
- Power valve blow-out protection
- Vacuum ports:
2 full manifold, 1 timed vacuum
- 100% wet-flow tested and street calibrated

OPTIONAL PARTS & KITS

P/N	DESCRIPTION
20-59	Quick change secondary spring kit
20-88	Throttle cable/return spring bracket kit
20-95	GM A.O.D. transmission bracket kit
17-6	Spread bore manifold adapter

CARBURETORS

FUEL
METERING

THROTTLE
BODIES

FUEL PUMPS

INTAKE
MANIFOLDS

SPRINGS/SHOCKS

CYLINDER
HEADS

SYSTEMS

WATER
PUMPS

DRESS-UP

BATTERY

STREET & TRUCK
ADAPTERS

PAINTS/SEALS

HAZARD/
WARNING



600 CFM Four Barrel

Part # **60-603^(B)**

Features

- Model 4160 w/ center hung floats
- Chrome & Purple / Chrome fuel line
- Electric choke
- Ford A/Tkickdown
- Vacuum secondaries
- Power valve blow-out protection
- Vacuum ports:
2 full manifold, 1 timed vacuum
- 100% wet-flow tested and street calibrated

OPTIONAL PARTS & KITS

P/N	DESCRIPTION
20-59	Quick change secondary spring kit
20-88	Throttle cable/return spring bracket kit
20-95	GM A.O.D. transmission bracket kit
17-6	Spread bore manifold adapter



600 CFM Four Barrel

Part # **60-604^(B)**

Features

- Model 4160 w/ center hung floats
- Chrome & Chevy Orange / Chrome fuel line
- Electric choke
- Ford A/Tkickdown
- Vacuum secondaries
- Power valve blow-out protection
- Vacuum ports:
2 full manifold, 1 timed vacuum
- 100% wet-flow tested and street calibrated

OPTIONAL PARTS & KITS

P/N	DESCRIPTION
20-59	Quick change secondary spring kit
20-88	Throttle cable/return spring bracket kit
20-95	GM A.O.D. transmission bracket kit
17-6	Spread bore manifold adapter



600 CFM Four Barrel

Part # **60-605^(B)**

Features

- Model 4160 w/ center hung floats
- Chrome & Ford Blue / Chrome fuel line
- Electric choke
- Ford A/Tkickdown
- Vacuum secondaries
- Power valve blow-out protection
- Vacuum ports:
2 full manifold, 1 timed vacuum
- 100% wet-flow tested and street calibrated

OPTIONAL PARTS & KITS

P/N	DESCRIPTION
20-59	Quick change secondary spring kit
20-88	Throttle cable/return spring bracket kit
20-95	GM A.O.D. transmission bracket kit
17-6	Spread bore manifold adapter

(A) Not legal for street use in California on vehicles originally equipped with 2-barrel carburetors for which there was no 4-barrel option.

(B) Not legal for sale or use in California on any pollution controlled motor vehicles.

or See page 2 for symbol explanation.

Tech Line: 270-781-9741

25

Carburetors



600 CFM Four Barrel

Part # **60-606^(B)**

Features

- Model 4160 w/ center hung floats
- Chrome & White / Chrome fuel line
- Electric choke
- Ford A/Tkickdown
- Vacuum secondaries
- Power valve blow-out protection
- Vacuum ports:
 - 2 full manifold, 1 timed vacuum
- 100% wet-flow tested and street calibrated

OPTIONAL PARTS & KITS

P/N	DESCRIPTION
20-59	Quick change secondary spring kit
20-88	Throttle cable/return spring bracket kit
20-95	GM A.O.D. transmission bracket kit
17-6	Spread bore manifold adapter

STREET



650 CFM Four Barrel

Part # **0-80783C^(B)**

Features

- Model 4150
- Vacuum secondaries
- Universal calibration
- Electric choke
- Center hung float bowls
- Power valve blow-out protection
- 100% wet-flow tested and street calibrated

OPTIONAL PARTS & KITS

P/N	DESCRIPTION
20-88	Throttle cable/return spring bracket kit
34-150	Chrome fuel line
20-91	Ford Automatic transmission bracket kit
17-6	Spread bore manifold adapter

STREET



650 CFM Four Barrel

Part # **0-80555C^(B)**

Features

- Model 4175 spread bore
- **Q-Jet/Thermo-Quad replacement**
- Universal calibration
- Vacuum secondaries
- Vacuum for: PCV, EGR, power brakes, distributor, air cleaner & canister
- Electric choke
- Power valve blow-out protection
- 100% wet-flow tested and street calibrated

OPTIONAL PARTS & KITS

P/N	DESCRIPTION
20-88	Throttle cable/return spring bracket kit

STREET/STRIP



650 CFM Four Barrel

Part # **0-4777C^(B)**

Features

- Model 4150
- Unique shiny / chromate dip finish
- Double pump
- Mechanical secondaries
- Center hung float bowls
- Manual choke
- Power valve blow-out protection
- 100% wet-flow tested and calibrated

OPTIONAL PARTS & KITS

P/N	DESCRIPTION
20-88	Throttle cable/return spring bracket kit
34-150	Chrome fuel line
45-224	Electric choke kit
45-228	Manual choke control cable
17-6	Spread bore manifold adapter

(A) Not legal for street use in California on vehicles originally equipped with 2-barrel carburetors for which there was no 4-barrel option.

(B) Not legal for sale or use in California on any pollution controlled motor vehicles.

or See page 2 for symbol explanation.



650 CFM Four Barrel

Part # **0-80541-1**^(B)

Features

- Model 4150 HP
- Straight-leg boosters
- Calibrated for gasoline
- Double 30cc accelerator pumps
- Progressive mechanical secondaries
- Four-corner idle system
- Power valve blow-out protection
- Screw-in air bleeds
- Non-stick gaskets
- Notched secondary float w/ jet extensions
- 100% wet-flow tested and calibrated



660 CFM Four Barrel

Part # **0-4224**^(B)

Features

- Model 4160
- 2x4 (inline) intake manifold
- 1:1 mechanical linkage
- 50cc center discharge pump
- Side hung float bowls
- Single fuel inlet
- No choke
- 100% wet-flow test and calibrated



OPTIONAL PARTS & KITS

P/N	Description
1049-949	Air Cleaner Bail
121-325	Accelerator Pump Nozzle



670 CFM Four Barrel

Part # **0-80670**^(B)

Features

- Model 4150 w/ center hung floats
- Electric choke
- Quick-change vacuum secondary
- Ford A/Tkickdown
- Power valve blow-out protection
- 4 Vacuum ports (PCV, power brake, spark, accessories)
- Lifetime limited warranty
- 100% wet-flow tested and street calibrated

How to calculate CFM:

Engine size (CID) x maximum RPM / 3458 = CFM @ 100% volumetric efficiency

(A) Not legal for street use in California on vehicles originally equipped with 2-barrel carburetors for which there was no 4-barrel option.

(B) Not legal for sale or use in California on any pollution controlled motor vehicles.

See page 2 for symbol explanation.

- CARBURETORS**
- FUEL METERING
- THROTTLE BODIES
- FUEL PUMPS
- INTAKE MANIFOLDS
- SUPERSUCKERS
- CYLINDER HEADS
- SPARK
- WATER PUMPS
- DRESS-UP
- BATTERY
- STREET & TRUCK AIRBLEN
- POINT-OF-SALE
- MAINTENANCE

Tech Line: 270-781-9741

Carburetors



NEW!

670 CFM Four Barrel

Part # **0-90670^(B)**

Features

- Model 4150 w/ side hung floats
- Electric choke
- Quick-change vacuum secondary
- Spring-loaded needle and seat assemblies
- Ford A/Tkickdown
- Power valve blow-out protection
- 4 Vacuum ports (PCV, power brake, spark, accessories)
- High vacuum signal primary annular boosters
- One-piece, off-road fuel bowl vent tube design
- Lifetime limited warranty
- 100% wet-flow tested and calibrated



700 CFM Four Barrel

Part # **0-4778C^(B)**

Features

- Model 4150
- Unique shiny/chromate dip finish
- Double pump
- Mechanical secondaries
- Center hung float bowls
- Manual choke
- Power valve blow-out protection
- 100% wet-flow tested and calibrated

OPTIONAL PARTS & KITS

P/N	DESCRIPTION
20-88	Throttle cable/return spring bracket kit
34-150	Chrome fuel line
45-224	Electric choke kit
45-228	Manual choke control cable
17-6	Spread bore manifold adapter

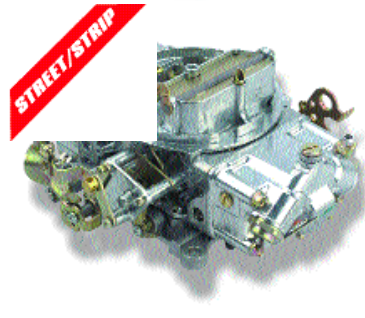

700 CFM Four Barrel

Part # **0-80572S^(B)**

Features

- Model 4150 w/ shiny finish
- Bright shiny finish
- S/B Chevrolet 1x4 140 series supercharger
- 50cc secondary pump
- Manual choke
- Manifold-referenced power valve
- 100% wet-flow tested and calibrated



NEW!

730 CFM Four Barrel

Part # **0-4609-1^(B)**

Features

- Model 4150 w/ center hung floats
- Legal for NHRASuper Stock and Stock Eliminator
- Vacuum secondaries
- Power valve blow-out protection
- 100% wet-flow tested and calibrated
- Center hung bowls
- Choke plate installed - no linkage



(A) Not legal for street use in California on vehicles originally equipped with 2-barrel carburetors for which there was no 4-barrel option.

(B) Not legal for sale or use in California on any pollution controlled motor vehicles.

or See page 2 for symbol explanation.



STREET



750 CFM Four Barrel

Part # **0-80508S**^(B)

Features

- Model 4160
- Bright shiny finish
- Electric choke
- Center hung float bowls
- Vacuum secondaries
- Power valve blow-out protection
- Ford A/Tkickdown
- 100% wet-flow tested and calibrated

OPTIONAL PARTS & KITS

P/N	DESCRIPTION
20-59	Quick change secondary spring kit
20-88	Throttle cable/return spring bracket kit
34-13S	Secondary metering block (shiny)
20-95	GM A.O.D. transmission bracket kit
20-91	Ford Automatic transmission bracket kit
34-160	Chrome fuel line
17-6	Spread bore manifold adapter

CRACKERS

FUEL METERING

THROTTLE BODIES

FUEL PUMPS

INTAKE MANIFOLDS

SPRINGS

CYLINDER HEADS

SYSTEMS

WATER PUMPS

DRESS-UP

BATTERY

STREET & TRUCK ADAPTERS

POINT-OF-SALE

INDEX/ VARIANTS

STREET/STRIP

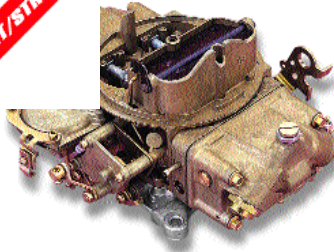

750 CFM Four Barrel

Part # **0-3310C**^(B)
 Part # **0-3310S**^(B)

Features

- Model 4160 w/ center hung floats
- Universal calibration
- Manual choke
- Vacuum secondaries
- Power valve blow-out protection
- Ford A/Tkickdown
- 100% wet-flow tested and calibrated

OPTIONAL PARTS & KITS

P/N	DESCRIPTION
20-59	Quick change secondary spring kit
20-88	Throttle cable/return spring bracket kit
34-13	Secondary metering block
34-160	Chrome fuel line
45-228	Manual choke control cable
20-91	Ford Automatic transmission bracket kit
17-6	Spread bore manifold adapter

NOTE: 0-3310C has classic finish, 0-3310S has shiny finish

STREET/STRIP

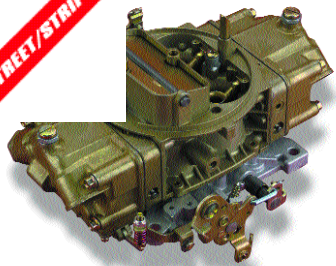

750 CFM Four Barrel

Part # **0-4779C**^(B)

Features

- Model 4150 w/ center hung floats
- Unique shiny/chromate dip finish
- Double pump
- Four-corner idle system
- Mechanical secondaries
- Manual choke
- Power valve blow-out protection
- 100% wet-flow tested and calibrated

OPTIONAL PARTS & KITS

P/N	DESCRIPTION
20-88	Throttle cable/return spring bracket kit
34-150	Chrome fuel line
45-224	Electric choke kit
45-228	Manual choke control cable
17-6	Spread bore manifold adapter

STREET/STRIP

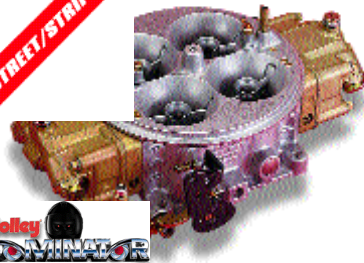

750 CFM Four Barrel

Part # **0-80186-1**^(B)

Features

- Annular boosters
- 2-circuit metering
- Progressive mechanical linkage
- Dual 50cc accelerator pumps
- Four-corner idle system
- Power valve blow-out protection
- Screw-in air bleeds
- Non-stick gaskets
- Notched secondary float w/ jet extensions
- 100% wet-flow tested and calibrated

(A) Not legal for street use in California on vehicles originally equipped with 2-barrel carburetors for which there was no 4-barrel option.

(B) Not legal for sale or use in California on any pollution controlled motor vehicles.

or See page 2 for symbol explanation.

Carburetors

STREET/STRIP

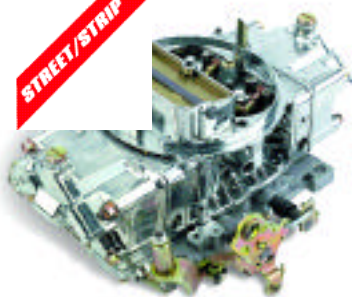

750 CFM Four Barrel

Part # **0-80573S**^(B)

Features

- Model 4150 w/shiny finish
- Small block Chevrolet 1x4, 170 series blower calibration
- Four-corner idle system
- Manual choke
- Dual 50cc accelerator pumps
- Manifold-referenced power valve
- 100% wet-flow tested and calibrated



STREET/STRIP



750 CFM Four Barrel

Part # **0-80576**^(B)

Features

- Model 4150HP design
- Designed for use on the WEIAND 671 supercharger (big block Chevrolet/Chrysler 392)
- Designed for use on the WEIAND 871 supercharger (small block Chevrolet/Chrysler 426)
- Four-corner idle system
- Replaceable air bleeds
- Dual 30cc accelerator pumps
- Manifold-referenced power valve
- 100% wet-flow tested and calibrated



STREET/STRIP



750 CFM Four Barrel

Part # **0-80529-1**^(B)

Features

- Model 4150 HP
- Double-step down leg boosters
- Calibrated for gasoline
- Single 30cc accelerator pump
- Vacuum secondaries w/ quick-change cover
- Four-corner idle system
- Power valve blow-out protection
- Screw-in air bleeds
- Non-stick gaskets
- Notched secondary float w/ jet extensions
- 3 Vacuum ports: 1 ported, 2 full manifold vacuum
- 100% wet-flow tested and calibrated

RACE OUT OF THE BOX

RACE

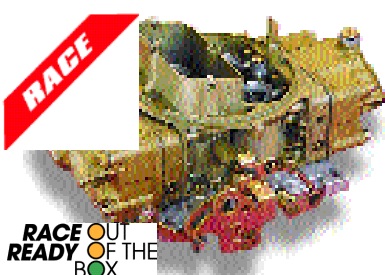

750 CFM Four Barrel

Part # **0-9379**^(B)

Features

- Model 4150 w/ center hung floats
- Double 30cc accelerator pumps
- DOMINATOR / dual feed float bowls
- Four-corner idle system
- Mechanical secondaries
- Annular boosters
- No choke
- 100% wet-flow tested and calibrated

RACE OUT OF THE BOX

(A) Not legal for street use in California on vehicles originally equipped with 2-barrel carburetors for which there was no 4-barrel option.

(B) Not legal for sale or use in California on any pollution controlled motor vehicles.

or See page 2 for symbol explanation.



RACE



RACE READY OUT OF THE BOX

750 CFM Four Barrel

Part # **0-80528-1**^(B)

Features

- Model 4150 HP
- Double-step down leg boosters
- Calibrated for gasoline
- Double 30cc accelerator pumps
- Progressive mechanical secondaries
- Four-corner idle system
- Power valve blow-out protection
- Screw-in air bleeds
- Non-stick gaskets
- Notched secondary float w/ jet extensions
- 100% wet-flow tested and calibrated

RACE



RACE READY OUT OF THE BOX

750 CFM Four Barrel

Part # **0-80535-1**^(B)

Features

- Model 4150 HP
- Double-step down leg boosters
- **Calibrated for Methanol**
- Double 50cc accelerator pumps
- Progressive mechanical secondaries
- Four-corner idle system
- Power valve blow-out protection
- Screw-in air bleeds
- Non-stick gaskets
- DOMINATOR / dual feed float bowls
- Notched secondary float w/ jet extensions
- 100% wet-flow tested and calibrated



770 CFM Four Barrel

Part # **0-80770**^(B)

Features

- Model 4150 w/ center hung floats
- Electric choke
- Quick-change vacuum secondary
- Ford A/Tkickdown
- Power valve blow-out protection
- 4 Vacuum ports (PCV, power brake, spark, accessories)
- Lifetime limited warranty
- 100% wet-flow tested and street calibrated



NEW!

770 CFM Four Barrel

Part # **0-90770**^(B)

Features

- Model 4150 w/ side hung floats
- Electric choke
- Quick-change vacuum secondary
- Spring-loaded needle and seat assemblies
- Ford A/Tkickdown
- Power valve blow-out protection
- 4 Vacuum ports (PCV, power brake, spark, accessories)
- High vacuum signal primary annular boosters
- One-piece, off-road fuel bowl vent tube design
- Lifetime limited warranty
- 100% wet-flow tested and calibrated

(A) Not legal for street use in California on vehicles originally equipped with 2-barrel carburetors for which there was no 4-barrel option.

(B) Not legal for sale or use in California on any pollution controlled motor vehicles.

See page 2 for symbol explanation.

CRACKERS
FUEL METERING
THROTTLE BODIES
FUEL PUMPS
INTAKE MANIFOLDS
SUPERCHARGERS
CYLINDER HEADS
SPARKS
WATER PUMPS
DRESS-UP
BATTERY
STREET & TRUCK AVENGER
POINT-OF-SALE
WARRANTY

Tech Line: 270-781-9741

Carburetors

STREET/STRIP



800 CFM Four Barrel

Part # **0-4780C**^(B)

Features

- Model 4150 w/ center hung floats
- Unique shiny/chromate dip finish
- 30cc primary, 50cc secondary pumps
- Mechanical secondaries
- Manual choke
- Power valve blow-out protection
- 100% wet-flow tested and calibrated

OPTIONAL PARTS & KITS

P/N	DESCRIPTION
20-88	Throttle cable/return spring bracket kit
34-150	Chrome fuel line
45-224	Electric choke kit
45-228	Manual choke control cable
17-6	Spread bore manifold adapter

STREET/STRIP



800 CFM Four Barrel

Part # **0-80574S**^(B)

Features

- Model 4150 w/shiny finish
- Big block Chevrolet 1x4, 170 series blower calibration
- Dual 50cc accelerator pumps
- Manual choke
- Manifold-referenced power valve
- 100% wet-flow tested and calibrated



RACE

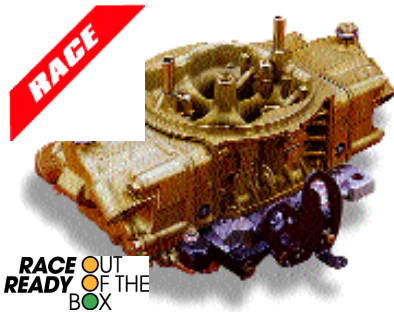

830 CFM Four Barrel

Part # **0-80785**^(B)

Features

- Intended for circle track racing
- Special Keith Dorton calibration for gasoline
- Model 4150 HP with mechanical progressive linkage
- Center hung float bowls with dual 30cc accelerator pumps
- Screw-in air bleeds
- Four-corner idle system
- Power valve blow-out protection
- Non-stick reusable gaskets
- Stainless steel throttle plates w/ buttonhead screws
- 100% wet-flow tested and calibrated



RACE READY OUT OF THE BOX

How to calculate CFM:

$$\text{Engine size (CID)} \times \text{maximum RPM} / 3456 = \text{CFM}$$

CFM @ 100% volumetric efficiency

(A) Not legal for street use in California on vehicles originally equipped with 2-barrel carburetors for which there was no 4-barrel option.

(B) Not legal for sale or use in California on any pollution controlled motor vehicles.

or See page 2 for symbol explanation.

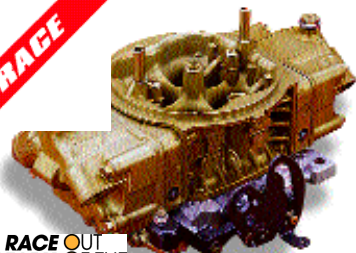

RACE READY OUT OF THE BOX

830 CFM Four Barrel

Part # **0-80509-1**^(B)

Features

- Model 4150 HP
- NASCAR approved
- Double-step, down-leg style boosters
- Progressive mechanical secondaries
- Double 30cc accelerator pumps
- Four-corner idle system
- Stainless steel throttle plates w/ buttonhead screws
- Screw-in air bleeds
- Power valve blow-out protection
- Non-stick gaskets
- 100% wet-flow tested and calibrated



RACE READY OUT OF THE BOX

830 CFM Four Barrel

Part # **0-80511-1**^(B)

Features

- Model 4150 HP
- NASCAR approved
- Annular-style boosters
- Progressive mechanical secondaries
- Double 30cc accelerator pumps
- Four-corner idle system
- Stainless steel throttle plates w/ buttonhead screws
- Screw-in air bleeds
- Power valve blow-out protection
- Non-stick gaskets
- 100% wet-flow tested and calibrated



830 CFM Four Barrel

Part # **0-9381**^(B)

Features

- Model 4150
- Center hung float bowls
- Dual 30cc accelerator pumps
- Annular style boosters
- Mechanical secondaries
- Four-corner idle system
- No choke
- 100% wet-flow tested and calibrated



850 CFM Four Barrel

Part # **0-4781C**^(B)

Features

- Model 4150 w/ center hung floats
- Unique shiny/chromate dip finish
- Double pump
- Mechanical secondaries
- Manual choke
- Power valve blow-out protection
- Four-corner idle system
- 100% wet-flow tested and calibrated

OPTIONAL PARTS & KITS

P/N	DESCRIPTION
20-88	Throttle cable/return spring bracket kit
34-150	Chrome fuel line
45-224	Electric choke kit
45-228	Manual choke control cable
17-6	Spread bore manifold adapter

CHARACTERISTICS
FUEL METERING
THROTTLE BODIES
FUEL PUMPS
INTAKE MANIFOLDS
SPRINGS/SHOCKS
CYLINDER HEADS
SYSTEMS
WATER PUMPS
DRESS-UP
BATTERY
STREET & TRUCK ADAPTERS
POINT-OF-SALE
INDEX/ABBREVIATION

(A) Not legal for street use in California on vehicles originally equipped with 2-barrel carburetors for which there was no 4-barrel option.

(B) Not legal for sale or use in California on any pollution controlled motor vehicles.

or See page 2 for symbol explanation.

Tech Line: 270-781-9741

Carburetors

STREET



850 CFM Four Barrel

Part # **0-80531**^(B)

Features

- Model 4150 w/ center hung floats
- Used on 502 crate motors
- Electric choke
- Vacuum secondaries
- Secondary power valve
- Ford A/Tkickdown
- 100% wet-flow tested and calibrated

OPTIONAL PARTS & KITS

P/N	DESCRIPTION
20-88	Throttle cable/return spring bracket kit
20-95	GM A.O.D. transmission bracket kit
20-59	Quick change secondary spring kit
34-150	Chrome fuel line
20-7	Chrysler throttle lever extension
17-6	Spread bore manifold adapter

RACE



850 CFM Four Barrel

Part # **0-9380**^(B)

Features

- Model 4150 w/ center hung float
- 30cc Primary accelerator pump
- 50cc Secondary accelerator pump
- Annular-style boosters
- Mechanical secondaries
- Four corner idle system
- No choke
- 100% wet-flow tested and calibrated

Holley
STREET AVENGER
SYSTEM



870 CFM Four Barrel

Part # **0-80870**^(B)

Features

- Model 4150 w/ center hung floats
- Electric choke
- Quick-change vacuum secondary
- Ford A/Tkickdown
- Power valve blow-out protection
- 4 Vacuum ports (PCV, power brake, spark, accessories)
- Lifetime limited warranty
- 100% wet-flow tested and street calibrated

How to calculate CFM:

$$\text{Engine size (CID)} \times \text{maximum RPM} / 3456 = \text{CFM}$$

CFM @ 100% volumetric efficiency

(A) Not legal for street use in California on vehicles originally equipped with 2-barrel carburetors for which there was no 4-barrel option.

(B) Not legal for sale or use in California on any pollution controlled motor vehicles.

or See page 2 for symbol explanation.



RACE OUT OF THE BOX READY

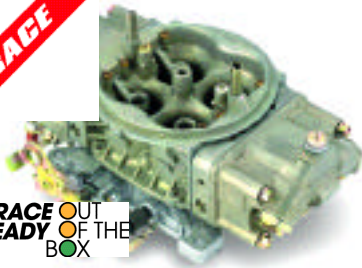

950 CFM Four Barrel

Part # 0-80496-1^(B)

Features

- Model 4150 HP
- Double-step down leg boosters
- Calibrated for gasoline
- Double 30cc accelerator pumps
- Progressive mechanical secondaries
- Four-corner idle system
- Power valve blow-out protection
- Screw-in air bleeds
- Dual feed DOMINATOR fuel bowls
- Notched secondary float w/ jet extensions
- Non-stick gaskets
- 100% wet-flow tested and calibrated



RACE OUT OF THE BOX READY



950 CFM Four Barrel

Part # 0-80498-1^(B)

Features

- Model 4150 HP
- Double-step down leg boosters
- **Calibrated for methanol**
- Double 50cc accelerator pumps
- Progressive mechanical secondaries
- Four-corner idle system
- Power valve blow-out protection
- Screw-in air bleeds
- Notched secondary float w/ jet extensions
- Non-stick gaskets
- 4500 DOMINATOR HPfuel bowls
- 100% wet-flow tested and calibrated

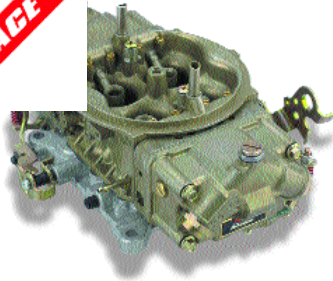

950 CFM Four Barrel

Part # 0-80577^(B)

Features

- Model 4150HPdesign
- Big block Chevrolet 2x4, 871 & 1071 blower calibration
- Four-corner idle system
- Screw-in air bleeds
- Dual 30cc accelerator pumps
- Manifold-referenced power valve
- 100% wet-flow tested and calibrated



CARBURETORS
FUEL METERING
THROTTLE BODIES
FUEL PUMPS
INTAKE MANIFOLDS
SUPERCHARGERS
CYLINDER HEADS
SYSTEMS
WATER PUMPS
DRESS-UP
BATTERY
STREET & TRUCK ADAPTERS
POINT-OF-SALE
MAINTENANCE/UPGRADES

(A) Not legal for street use in California on vehicles originally equipped with 2-barrel carburetors for which there was no 4-barrel option.

(B) Not legal for sale or use in California on any pollution controlled motor vehicles.

See page 2 for symbol explanation.

Tech Line: 270-781-9741

35

Carburetors



1000 CFM Four Barrel

Part # **0-80513-1**^(B)

Features

- Model 4150 HP
- Double-step down leg boosters
- Calibrated for gasoline
- 30cc primary accelerator pump
- 50cc secondary accelerator pump
- Progressive mechanical secondaries
- Four-corner idle system
- Power valve blow-out protection
- Screw-in air bleeds
- Notched secondary float w/ jet extensions
- Non-stick gaskets
- 100% wet-flow tested and calibrated



1000 CFM Four Barrel

Part # **0-80514-1**^(B)

Features

- Model 4150 HP
- Annular boosters
- Calibrated for gasoline
- 30cc primary accelerator pump
- 50cc secondary accelerator pump
- Progressive mechanical secondaries
- Four-corner idle system
- Power valve blow-out protection
- Screw-in air bleeds
- Notched secondary float w/ jet extensions
- Non-stick gaskets
- 100% wet-flow tested and calibrated



1050 CFM Four Barrel

Part # **0-8082-1**^(B)

Features

- 1 x 4 carburetor set-ups
- Annular boosters
- 2-circuit metering
- Progressive mechanical linkage
- Dual 50cc accelerator pumps
- Four-corner idle system
- Power valve
- Power valve blow-out protection
- Screw-in air bleeds
- Notched secondary float w/ jet extensions
- Non-stick gaskets
- 100% wet-flow tested and calibrated



1050 CFM Four Barrel

Part # **0-8896-1**^(B)

Features

- 1 x 4 carburetor set-ups
- Annular boosters
- 3-circuit metering
- "Soft" progressive mechanical linkage
- Dual 50cc accelerator pumps
- Four-corner idle system
- Power valve blow-out protection
- Screw-in air bleeds
- Notched secondary float w/ jet extensions
- Non-stick gaskets
- 100% wet-flow tested and calibrated

(A) Not legal for street use in California on vehicles originally equipped with 2-barrel carburetors for which there was no 4-barrel option.

(B) Not legal for sale or use in California on any pollution controlled motor vehicles.

See page 2 for symbol explanation.



1050 CFM Four Barrel

Part # **0-80586**^(B)

Features

- 1x4 carburetor set-ups
- 3-circuit metering
- Annular boosters
- Four-corner idle system
- **Calibrated for methanol**
- Screw-in air bleeds
- Notched secondary float w/ jet extension
- Dual 50cc accelerator pumps
- Progressive mechanical linkage
- Non-stick gaskets
- 100% wet-flow tested and calibrated

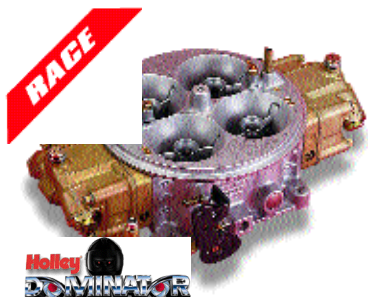

1050 CFM Four Barrel

Part # **0-9375-1**^(B)

Features

- 2 x 4 carburetor set-ups
- Annular boosters
- 3-circuit metering
- "Soft" progressive mechanical linkage
- Dual 50cc accelerator pumps
- Four-corner idle system
- Screw-in air bleeds
- Notched secondary float w/ jet extension
- Non-stick gaskets
- 100% wet-flow tested and calibrated

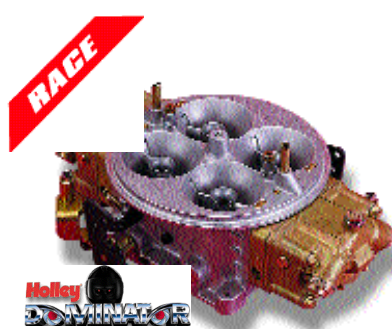

1150 CFM Four Barrel

Part # **0-7320-1**^(B)

Features

- 1 x 4 carburetor set-ups
- Annular boosters
- 2-circuit metering
- Progressive mechanical linkage
- Dual 50cc accelerator pumps
- Four-corner idle system
- Power valve blow-out protection
- Screw-in air bleeds
- Notched secondary float w/ jet extension
- Non-stick gaskets
- 100% wet-flow tested and calibrated

How to calculate CFM:
Engine size (CID) x maximum RPM / 3456 = CFM
CFM @ 100% volumetric efficiency

CRACKERS
FUEL METERS
THROTTLE BODIES
FUEL PUMPS
INTAKE MANIFOLDS
SUPERCHARGERS
CYLINDER HEADS
SYSTEMS
WATER PUMPS
DRESS-UP
BATTERY
STREET & TRUCK ADAPTERS
POINT-OF-SALE
INDEX/ALPHABETIC

(A) Not legal for street use in California on vehicles originally equipped with 2-barrel carburetors for which there was no 4-barrel option.

(B) Not legal for sale or use in California on any pollution controlled motor vehicles.

See page 2 for symbol explanation.

Tech Line: 270-781-9741

Carburetors



1150 CFM Four Barrel

Part # **0-80556-1**^(B) **3**

Features

- 1 x 4 carburetor set-ups
- Annular boosters
- 3-circuit metering
- "Soft" progressive mechanical linkage
- Dual 50cc accelerator pumps
- Four-corner idle system
- Power valve blow-out protection
- Screw-in air bleeds
- Notched secondary float w/ jet extensions
- Non-stick gaskets
- 100% wet-flow tested and calibrated



1150 CFM Four Barrel

Part # **0-9377-1**^(B) **3**

Features

- 2 x 4 carburetor set-ups
- Annular boosters
- 3-circuit metering
- "Soft" progressive mechanical linkage
- Dual 50cc accelerator pumps
- Four-corner idle system
- Screw-in air bleeds
- Notched secondary float w/ jet extensions
- Non-stick gaskets
- 100% wet-flow tested and calibrated



(A) Not legal for street use in California on vehicles originally equipped with 2-barrel carburetors for which there was no 4-barrel option.

(B) Not legal for sale or use in California on any pollution controlled motor vehicles.

1 **2** or **3** See page 2 for symbol explanation.



1250 CFM Four Barrel

Part # **0-80532-1** (B) 

Features

- 1 x 4 carburetor set-ups
- Annular boosters
- 3-circuit metering
- Progressive mechanical linkage
- Dual 50cc accelerator pumps
- Four-corner idle system
- Power valve blow-out protection
- Screw-in air bleeds
- Notched secondary float w/ jet extensions
- Non-stick gaskets
- 100% wet-flow tested and calibrated



1250 CFM Four Barrel

Part # **0-80533-1** (B) 

Features

- 2 x 4 carburetor set-ups
- Annular boosters
- 3-circuit metering
- Progressive mechanical linkage
- Dual 50cc accelerator pumps
- Four-corner idle system
- Power valve blow-out protection
- Screw-in air bleeds
- Notched secondary float w/ jet extensions
- Non-stick gaskets
- 100% wet-flow tested and calibrated

How to calculate CFM:

Engine size (CID) x maximum RPM / 3456 = CFM
CFM @ 100% volumetric efficiency



CARBURETORS

FUEL
MIXTURE

THROTTLE
BODIES

FUEL PUMPS

INTAKE
MANIFOLDS

SUPPLEMENTARY

CYLINDER
HEADS

SPARK
PLUGS

WATER
PUMPS

DRESS-UP

BATTERY



STREET & TRUCK
AIRBLEN

POINT-OF-SALE

WARRANTY

(A) Not legal for street use in California on vehicles originally equipped with 2-barrel carburetors for which there was no 4-barrel option.

(B) Not legal for sale or use in California on any pollution controlled motor vehicles.

 or  See page 2 for symbol explanation.

Tech Line: 270-781-9741

39

Carburetors

Replacement Carburetors

Features

- All emission provisions
- Engineered to improve performance
- Bolt-on installation
- Square and Spread bore bolt patterns
- Vacuum and mechanical secondaries

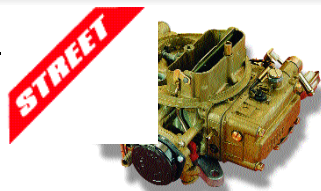

Model 4160 Square Flange



Model 4175 Spread Bore

MAKE	YEAR	ENGINE	SQUARE FLANGE		SPREAD BORE	
			PART #	CFM	PART #	CFM
AMC	1965-69	All V8s	0-80457S v(A,E) ◆	600	N/A	N/A
Buick	1967	400	0-80457S v(A,E) ◆	600	0-80555C v(A) ◆	650
		430	0-80508S v(A,E) ◆	750	0-80555C v(A) ◆	650
	1968-69	350,400	0-80457S v(A,E) ◆	600	0-80555C v(A) ◆	650
		430,455	0-80508S v(A,E) ◆	750	N/A	N/A
	1970	350,455	0-80450 v(A,E) ◆	600	N/A	N/A
	1971	455	0-80450 v(A,E) ◆	600	N/A	N/A
	1972	350,455	0-80450 v(A,E) ◆	600	N/A	N/A
	1973-74	350,455	0-80450 v(A,E) ◆	600	N/A	N/A
	1975-79	350,455	0-80451 v(A,E) ◆	600	N/A	N/A
	Chevrolet	1966-69	327,350,402	0-80457S v(A,E) ◆	600	0-80555C v(A) ◆
427,454			0-80508S v(A,E) ◆	750	0-6210 m(A) ◆	650
1970		307	0-80450 v (A,E) ◆	600	N/A	N/A
		350,402	0-80450 v(A,E) ◆	600	0-6210 m(A) ◆	650
1971		307,350,402,454	0-80450 v(A,E) ◆	600	N/A	N/A
1972		350,454	0-80450 v(A,E) ◆	600	N/A	N/A
1973-74		350,454	0-80450 v(A,E) ◆	600	0-7002 v(A) ◆	650
1975-76		400,454	0-80451 v(A,E) ◆	600	N/A	N/A
1975-78		350 (5.7L)	0-80451 v(A,E) ◆	600	0-9895 v(A) ◆	650
Chevrolet/ GMC Trucks		1968	327; 396 (10 Series)	0-80457S v(A,E,F) ◆	600	0-80555C v(A,F) ◆
	1969	350 (10 Series)	0-80457S v(A,E,F) ◆	600	0-80555Cv(A,F) ◆	650
		396 (10 Series)	0-80508S v(A,E,F) ◆	750	0-80555C v(A,F) ◆	650
	1970-72	350 (10 Series)	0-80450 v(A,E,F) ◆	600	N/A	N/A
		402,454	0-80450 v(A,E,F) ◆	600	N/A	N/A
	1973	350,454	0-80450 v(A,E,F) ◆	600	0-7002 v(A,F) ◆	650
	1974	350 (10,20 Series)	0-80450 v(A,E,F) ◆	600	N/A	N/A
		454	0-80450 v(A,E,F) ◆	600	N/A	N/A
	1975-78	350 U8500GVW	0-80460 v(A,E,F) ◆	600	N/A	N/A
		400 U8500GVW	0-80460 v(A,E,F) ◆	600	N/A	N/A
1979-80	350 U8500GVW	0-80451 v(A,E,F) ◆	600	N/A	N/A	
1980-85	350 (17080213)	N/A	N/A	0-80128 v(A,F) ◆	650	

v Vacuum Secondary
m Mechanical Secondary

(A) Not legal for street use in California on vehicles originally equipped with 2-barrel carburetors for which there was no 4-barrel option.

(B) Not legal for sale or use in California on any pollution-controlled motor vehicles.

(E) Adapter P/N 17-6 is required when using a "Square Flange" carburetor on a "Spread Bore" manifold.

(F) It is not recommended or advised that the Holley Street Legal carburetors which are listed for trucks be used on motor homes.

◆ and ◆ See page 2 for symbol explanation. * Not for lean-burn engines or HD trucks.



MAKE	YEAR	ENGINE	SQUARE FLANGE		SPREAD BORE		CATEGORIES
			PART #	CFM	PART #	CFM	
Chrysler	1967-69	318,383	0-80457S v(A,E) ◆	600	N/A	N/A	CARBURETORS FUEL METERING THROTTLE BODIES FUEL PUMPS INTAKE MANIFOLDS SUPERCHARGERS CYLINDER HEADS SCRAMBLER WATER PUMPS DRESS-UP BATTERY STREET & TRUCK ADAPTERS POINT-OF-SALE NEW/ VARIANTS
		440	0-80508S v (A,E) ◆	750	N/A	N/A	
	1970-71	383,440	0-80454 v(A,E) ◆	600	N/A	N/A	
		360,440	0-80454 v(A,E) ◆	600	N/A	N/A	
	1972	400	0-80454 v(A,E) ◆	600	N/A	N/A	
		360,400,440	0-80454 v(A,E) ◆	600	N/A	N/A	
	1973-76	318	0-80454 v(A,E) ◆	600	N/A	N/A	
		318,360,400 (Calif.)*	0-80454 v(A,E) ◆	600	0-80491 v(A) ◆	650	
	1975-76	440 (A-134)	0-80454 v(A,E) ◆	600	N/A	N/A	
		440 (A-134)(Calif.)*	0-80454 v(A,E) ◆	600	0-80491 v(A) ◆	650	
	1977	318,360,400,440	0-80454 v(A,E) ◆	600	N/A	N/A	
		318,360,440 (Calif.)*	0-80454 v(A,E) ◆	600	0-80491 v(A) ◆	650	
1978-82	318,360,440 (Calif.)*	0-80454 v(A,E) ◆	600	0-80491 v(A) ◆	650		
	318,360,440 (Calif.)*	N/A	N/A	0-80491 v(A) ◆	650		
Dodge	1967-69	318,383	0-80457S v(A,E) ◆	600	N/A	N/A	
		440	0-80508S v (A,E) ◆	750	N/A	N/A	
	1970-71	383,440	0-80454 v(A,E) ◆	600	N/A	N/A	
		360,440	0-80454 v(A,E) ◆	600	N/A	N/A	
	1972	400	0-80454 v(A,E) ◆	600	N/A	N/A	
		360,400,440	0-80454 v(A,E) ◆	600	N/A	N/A	
	1973-76	318	0-80454 v(A,E) ◆	600	N/A	N/A	
		318,360,400 (Calif.)*	0-80454 v(A,E) ◆	600	0-80491 v(A) ◆	650	
	1975-76	440 (A-134)	0-80454 v(A,E) ◆	600	N/A	N/A	
		440 (A-134)(Calif.)*	0-80454 v(A,E) ◆	600	0-80491 v(A) ◆	650	
	1977	318,360,400,440	0-80454 v(A,E) ◆	600	N/A	N/A	
		318,360,440 (Calif.)*	0-80454 v(A,E) ◆	600	0-80491 v(A) ◆	650	
1978-82	318,360,440 (Calif.)*	0-80454 v(A,E) ◆	600	0-80491 v(A) ◆	650		
	318,360,440 (Calif.)*	N/A	N/A	0-80491 v(A) ◆	650		
Dodge Truck	1974	318,360,440 (Calif.)*	N/A	N/A	0-80491 v(A,F) ◆	650	
		318,360	0-80454 v(A,E) ◆	600	N/A	N/A	
	1975-77	318,360,440 (Calif.)*	N/A	N/A	0-80491 v(A,F) ◆	650	
		318,360	0-80454 v(A,E,F) ◆	600	N/A	N/A	
	1978	400 (over 6000 GVW)	0-80454 v(A,E,F) ◆	600	N/A	N/A	
		318,360,440 (Calif.)*	N/A	N/A	0-80491 v(A,F) ◆	650	
	1979	318	0-80454 v(A,E,F) ◆	600	N/A	N/A	
		360 (exc. Calif.)*	0-80454 v(A,E,F) ◆	600	N/A	N/A	
	1980-83	318,360,440 (Calif.)*	N/A	N/A	0-80491 v(A,F) ◆	650	
		318,360,440 (Calif.)*	N/A	N/A	0-80491 v(A,F) ◆	650	
1985	360 (Rochester carb.)	N/A	N/A	N/A	650		
Ford	1958-60	332, 352, 361	0-1848-1 v(A) ◆	465	N/A	N/A	
	1961-67	All V-8	0-80457S v(A) ◆	600	N/A	N/A	
	1968-69	302,351W	0-80457S v(A) ◆	600	N/A	N/A	
		390,428	0-80508S v(A) ◆	750	N/A	N/A	
	1970-72	390	0-80453 v(A) ◆	600	N/A	N/A	
	1970-74	302	0-80453 v(A) ◆	600	N/A	N/A	
	1977-78	351M	0-80453 v(A) ◆	600	N/A	N/A	
Ford Truck	1968-69	302,360	0-80457S v(A,F) ◆	600	N/A	N/A	
		390,428,429	0-80508S v(A,F) ◆	750	N/A	N/A	
	1970-72	360,390	0-80453 v(A,F) ◆	600	N/A	N/A	
		302	0-80453 v(A,F) ◆	600	N/A	N/A	
	1975-76	460 (Ranchero)	0-80452 v(A) ◆	600	N/A	N/A	
		390 PU U8500GVW	0-80452 v(A) ◆	600	N/A	N/A	
	1975-77	351W	0-80452 v(A) ◆	600	N/A	N/A	
		460 Van U8500GVW	0-80452 v(A) ◆	600	N/A	N/A	
	1975-80	460 PU U8500GVW	0-80452 v(A) ◆	600	N/A	N/A	
		351M,400	0-80452 v(A) ◆	600	N/A	N/A	
	1977-80	351M,400	0-80452 v(A) ◆	600	N/A	N/A	
		302	0-80452 v(A) ◆	600	N/A	N/A	
	1979-80	302	0-80452 v(A) ◆	600	N/A	N/A	

Tech Line: 270-781-9741

Carburetors

MAKE	YEAR	ENGINE	SQUARE FLANGE		SPREAD BORE	
			PART #	CFM	PART #	CFM
Mercury	1958-60	332, 352, 361	0-1848-1 v(A) ◆	450	N/A	N/A
	1961-67	All V-8	0-80457S v(A) ◆	600	N/A	N/A
	1968-69	302,351W	0-80457S v(A) ◆	600	N/A	N/A
		390,428	0-80508S v(A) ◆	750	N/A	N/A
	1970-72	390	0-80453 v(A) ◆	600	N/A	N/A
	1970-74	302	0-80453 v(A) ◆	600	N/A	N/A
	1977-78	351M	0-80453 v(A) ◆	600	N/A	N/A
			0-80453 v(A) ◆	600	N/A	N/A
Oldsmobile	1967-69	350	0-80457S v(A,E) ◆	600	0-80555C v(A) ◆	650
		455	0-80508S v(A,E) ◆	750	N/A	N/A
	1970-74	350,455	0-80450 v(A,E) ◆	600	N/A	N/A
	1975-76	400,455	0-80451 v(A,E) ◆	600	N/A	N/A
	1975-79	350	0-80451 v(A,E) ◆	600	N/A	N/A
			0-80451 v(A,E) ◆	600	N/A	N/A
Plymouth	1967-69	318	0-80457S v(A,E) ◆	600	N/A	N/A
		383,440	0-80508S v(A,E) ◆	750	N/A	N/A
	1970-71	383,440	0-80454 v(A,E) ◆	600	N/A	N/A
			0-80454 v(A,E) ◆	600	N/A	N/A
	1972	360,440	0-80454 v(A,E) ◆	600	N/A	N/A
			0-80454 v(A,E) ◆	600	N/A	N/A
	1973-76	360,400,440	0-80454 v(A,E) ◆	600	N/A	N/A
			0-80454 v(A,E) ◆	600	N/A	N/A
	1975-76	318	0-80454 v(A,E) ◆	600	N/A	N/A
			0-80454 v(A,E) ◆	600	N/A	N/A
	1975-76	318,360,400 (Calif.)*	0-80454 v(A,E) ◆	600	0-80491 v(A) ◆	650
			440 (A-134)	0-80454 v(A,E) ◆	600	N/A
			440 (A-134)(Calif.)*	0-80454 v(A,E) ◆	600	0-80491 v(A) ◆
	1977	318,360,400,440	0-80454 v(A,E) ◆	600	N/A	N/A
			0-80454 v(A,E) ◆	600	0-80491 v(A) ◆	650
1978-82	318,360,440 (Calif.)*	0-80454 v(A,E) ◆	600	0-80491 v(A) ◆	650	
		N/A	N/A	0-80491 v(A) ◆	650	
Pontiac	1967-69	350	0-80457S v(A,E) ◆	600	0-80555C v(A) ◆	650
		400,455 w/o Ram Air	0-80508S v(A,E) ◆	750	N/A	N/A
	1972	307,400	0-80450 v(A,E) ◆	600	N/A	N/A
			0-80450 v(A,E) ◆	600	N/A	N/A
	1973	400	0-80450 v(A,E) ◆	600	N/A	N/A
	1970-74	350,400,455	0-80450 v(A,E) ◆	600	N/A	N/A
	1975-79	350	0-80450 v(A,E) ◆	600	N/A	N/A
0-80451 v(A,E) ◆			600	N/A	N/A	

v Vacuum Secondary
m Mechanical Secondary
(A) Not legal for street use in California on vehicles originally equipped with 2-barrel carburetors for which there was no 4-barrel option.
(B) Not legal for sale or use in California on any pollution-controlled motor vehicles.
(E) Adapter P/N 17-6 is required when using a "Square Flange" carburetor on a "Spread Bore" manifold.
(F) It is not recommended or advised that the Holley Street Legal carburetors which are listed for trucks be used on motor homes.
◆ and ◆ See page 2 for symbol explanation. * Not for lean-burn engines or HD trucks.





O.E. Muscle Car Carburetors



Chevrolet

PART #	O.E. NUMBER	APPLICATION	CHOKE	CFM
0-3367	3884505	1966 Corvette 327 300/350 M/T	Remote	585
0-3370	3882835	1966 Corvette 427/390 All Trans.	Remote	585
0-3659	3902353	1967-69 Corvette 427 3x2 (outboard carb.)	N/A	466
0-3810	3906631	1967 Corvette 327 300/350 M/T	Remote	585
0-4053	3923389	1968 Z-28 & Chevelle 302 & 427 All Trans.	Remote	780
0-4055-1	3940929	1968-69 Corvette 427 3x2 (center carb.) M/T	Remote	350

Chrysler

PART #	O.E. NUMBER	APPLICATION	CHOKE	CFM
0-4144-1	3418550	1969-70 440/390 3x2 (center carb.)	Remote	350
0-4235	2946263	1968 426 Hemi (right side carb)	N/A	770
0-4236	2946262	1968 426 Hemi (left side carb)	N/A	770
0-4365-1	3462373	1969-70 440/390 3x2 (outboard carb.)	N/A	500
0-4790	3577185	1970-71 340 3x2 (outboard carb.)	N/A	500
0-4792	3577183	1970-71 340 3x2 (center carb.) A/T	Remote	350

How to calculate CFM:
Engine size (CID) x maximum RPM / 3456 = CFM
CFM @ 100% volumetric efficiency

or See page 2 for symbol explanation.

Tech Line: 270-781-9741

43

- CARBURETORS**
- FUEL METERING
- THROTTLE BODIES
- FUEL PUMPS
- INTAKE MANIFOLDS
- SUPPLEMENTARY
- CYLINDER HEADS
- SYMBAK
- WATER PUMPS
- DRESS-UP
- BATTERY
- STREET & TRUCK ADAPTERS
- PUMP-UP-SIDE
- INDEX/ABBREVIATION

Carburetors

Service / Tuning Manuals



36-171



36-175

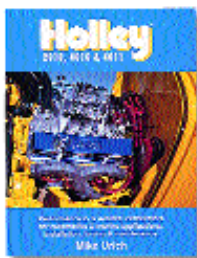

36-164



36-155



36-136

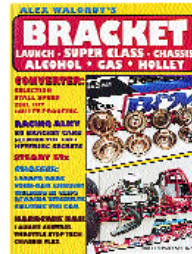

36-202



36-203



36-254

Learn More About Holley Fuel System Products!

•Tuning •Modifications •Selection •Servicing

High Performance Engine Assembly Guide

By Alex Walordy. A practical guide to the best ways of prefitting and assembling Chevy small and big block engines. Offers installation tips on cam bearings, prepping heads and figuring compression ratios. 100 pages. Over 300 photos.

36-171 \$16.95

Super Tuning

By Alex Walordy. Provides latest tuning information on PRO-JECTION® and PRO-JECTION® 4 fuel injection systems from Holley. Includes a complete section on DOMINATOR® carburetors. Holley double pumper and track tuning.

36-175 \$16.95

Holley Models 4010 & 4011

By Mike Ulrich. Covers how to select the right carburetor for automotive and marine applications. Installation instructions and tips. Disassembly and repair. Completely illustrated with all-new photos and drawings. 96 pages.

36-164

Supertuning Holley Carburetors

By Alex Walordy. A guide to modifying Holley carburetors. Offers detailed information on tuning carburetors for drag and bracket racing, oval track and street performance. Includes troubleshooting and assembly tips. Fully illustrated. 68 pages.

36-155 \$14.95

Holley Carburetors Manual

By Dave Emanuel. A detailed comprehensive guide to proper selection and modification of Holley carburetors for competition. Includes turbocharging modifications. Tips on rebuilding Holley two and four barrel models. Illustrated. 128 pages.

36-136 \$18.95

Bracket

By Alex Walordy. Everything you need to know about building a competitive bracket car. BRACKET covers key technical information on the chassis, transmission converter, electronics, ignition, carburetion and using alcohol fuel. Information that you will need to know and understand in order to build a car that will hit its numbers consistently.

36-202 \$16.95

Ways To Win Et Bracket

By Alex Walordy. Winning is everything. Having a fast and consistent car is only one element of the winning equation. Thinking is the other and this Alex book gets into the nitty gritty of racing smart and planning. An invaluable tool if you take your racing seriously!

36-203 \$16.95

Hot Holleys

Contains extensive technical information on 4150 HP and Dominator HP carburetors. Reviews carburetor tuning, fuel systems, using spacers, linkages, manifolds and mountain motor applications. Covers use of gas and alcohol fuels and proven racing modifications that win races.

36-254



Service / Tuning Manuals



36-51-7

Illustrated Parts & Specs Manual

A technical aid showing exploded illustrations of current Holley carburetor models. Complete list of parts and adjustment specifications. Designed for the professional service technician.

Holley Carburetors, Manifolds & Fuel Injection

By Bill Fisher and Mike Ulrich. New for 1994. Covers all 2010, 2300, 4010/4011, 4150/4160/4180, 4165/4175 and 4500 performance carburetors. Includes Holley Pro-Jection 1-bbl. through 4-bbl. models with installation and tuning information not found in any other publication. Explains how to select and install the "right" carburetor and manifold. Plus alcohol modifications for short track racing. 224 pages.

36-73 \$17.95

Holley Carburetor Numerical Listing

Contains a complete list of all Holley carburetors, including automotive, farm, industrial and marine along with their corresponding repair kits. The listing consists of over 3,500 applications covering vehicles from 1957 to the present.

36-168 \$8.85



36-168

Holley Model 4150 & 4160 Carburetor Handbook

By M. Ulrich. Includes application recommendations, tuning and repair.

36-133 \$12.95

Holley Tech

Everything you need to know about custom tuning and troubleshooting the Holley 4150 HP and Dominator HP carburetors. Includes information on machining base plates and changing linkages or cams; 2-circuit and 3-circuit carburetor metering blocks and main bodies; idle and main circuit modifications.

36-275



36-275



36-133

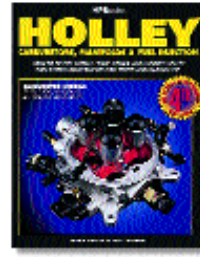

36-73

CARBURETORS

FUEL
METERING

THROTTLE
BODIES

FUEL PUMPS

INTAKE
MANIFOLDS

SUPERSCHARGERS

CYLINDER
HEADS

SYSTEMS

WATER
PUMPS

DRESS-UP

BATTERY

STREET & TRUCK
AIRBLEN

POINT-OF-SALE













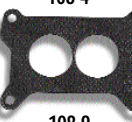





INDEX/
VARIANTS

Tech Line: 270-781-9741

45

Carburetors

Gaskets

 108-4	 108-71	Air Cleaner Gasket Diameter: 5" Thickness: .060" Quantity: 3/pkg	Part # 108-4	Base Gasket and Studs Model: 4010, 4150 and 4160 Bore Size: 1-3/4" Thickness: 5/16"	Part # 108-12
 108-9	 108-52	Air Cleaner Gasket Diameter: 5" Thickness: .200"	Part # 108-62	Base Gasket Model: 4150 and 4160 Bore Size: 1-13/16" Thickness: 1/16"	Part # 108-10
 108-51	 108-58	Air Cleaner Gasket Diameter: 7" Thickness: .060"	Part # 108-73	Base Gasket Model: 4150 and 4160 Bore Size: 1-13/16" Thickness: 5/32"	Part # 108-76
 108-18	 108-58	Air Cleaner Gasket Diameter: "D"-shaped Application: 3x2 Carburetors Quantity: 3/pkg	Part # 108-71	Base Gasket Model: 4165 and 4175 Bore Size: 1-3/8" primary 2" secondary Thickness: 5/8"	Part # 108-19
 108-18	 108-12	Base Gasket Model: 2010 and 2300 Bore Size: 1-13/16" Thickness: .060"	Part # 108-9	Base Gasket Model: 4165 and 4175 Bore Size: 1-1/2" pri 2" sec 1-3/8" pri 2" sec Thickness: 1/4"	Part # 108-25 108-118
 108-10	 108-19	Base Gasket and Studs Model: 2010 and 2300 Bore Size: 1-1/2" Thickness: .250"	Part # 108-52	Base Gasket Model: 4500 and 4500 DOMINATOR HP Thickness: 1/16"	Part # 108-84-2
 108-25	 108-84-2	Base Gasket and Studs Model: 4150, 4160 and 4180 Bore Size: 1-9/16" Thickness: .260"	Part # 108-51	Base Insulator (Phenolic) Model: 4011, 4165 and 4175 Bore Size: 1-3/8" primary 2-3/8" secondary Thickness: 5/8"	Part # 108-37
 108-25	 108-84-2	Base Gasket Model: 4150, 4160 and 4180 Bore Size: 1-9/16" Thickness: .204"	Part # 108-58	Base Gasket Model: 4500 Dominator HP Thickness: .060"	Part # 108-99
 108-99	 108-115	Base Gasket Model: 4010, 4150 and 4160 Bore Size: 1-3/4" Thickness: 5/16"	Part # 108-18	Base Gasket Model: Split Dominators Thickness: 5/16"	Part # 108-115



Gaskets

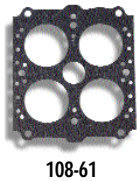
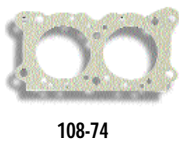
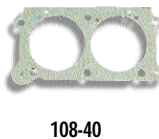
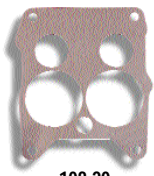

Base Plate Part #
 Model: Rochester
 Quadra-Jet
 Bore Size:
 1-3/8" primary
 2-3/8" secondary
 Thin stainless steel
108-20

Fuel Bowl Plug Gasket – Quick Change Part #
 All Holley quick change fuel bowls
108-77

Fuel Bowl Screw Gasket Part #
 All Holley fuel bowl screws, 20/pkg
108-2-20

Heat Shield Part #
 Model: Rochester
 Quadra-Jet
 Holley 4011, 4165
108-69

Heat Shield Part #
 Model: 4010, 4150 and 4160
108-70

Transfer Tube O-Ring Part #
 Use with fuel transfer tube P/N 26-19, P/N 26-20 and P/N 26-21
26-37

Transfer Tube Seal Part #
 Use with fuel transfer tube P/N 26-114, P/N 26-115 and P/N 26-116
108-97

Vacuum Passage Gasket – Cork Part #
 Seals vacuum passages to vacuum secondary and automatic choke housings, 20/pkg
108-67-20

Throttle Body Gasket Part #
 Model: 2300 carburetor
 List R4412
108-40

Throttle Body Gasket Part #
 Model: 2300 carburetor
 List R7448
108-74

Throttle Body Gasket Part #
 Models 4150/4160 carburetors
 Bore Size:
 1-7/16" x 1-7/16"
108-61

Throttle Body Gasket Part #
 Models 4150/4160 carburetors
 Bore Size:
 1-9/16" x 1-9/16"
108-3

Throttle Body Gasket Part #
 Models 4150/4160 carburetors
 Bore Size:
 1-11/16" x 1-11/16"
108-5

Throttle Body Gasket Part #
 Models 4150/4160 carburetors
 Bore Size:
 1-3/4" x 1-3/4"
108-7

Throttle Body Gasket Part #
 Models 4180 carburetor
108-57

CARBURETORS

FUEL

THROTTLE BODIES

FUEL PUMPS

INTAKE MANIFOLDS

SUPPLEMENTARY

CYLINDER HEADS

SYSTEMS

WATER PUMPS

DRESS-UP

BATTERY

STREET & TRUCK ADAPTERS

POINT-OF-SALE

NIKE/VEHICULAR

Tech Line: 270-781-9741

47

Carburetors

Gaskets

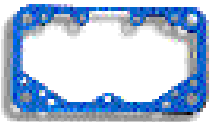

108-92-2

Blue Non-Stick Fuel Bowl Gasket

Part #

For Model 4165 and some 4150/4160 (primary side) and 2300. Primary bowl gasket for 4175, except computer-controlled. Available in 2/pkg or bulk orders of 100 or more.

2/pkg **108-92-2**
100 or more **8R1910-1**



108-83-2

Blue Non-Stick Fuel Bowl Gasket

Part #

Models 2300, 4150/60 and 4500 two circuit carburetors. Available in 2/pkg or bulk orders of 100 or more.

2/pkg **108-83-2**
100 or more **8R1911-1**

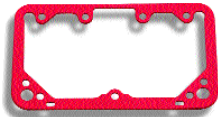

108-105

Red Non-Stick Fuel Bowl Gasket

Part #

Models 2300, 4150/60, all 4150 HP and 4500 two circuit carburetors.

2/pkg **108-105**

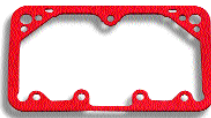

108-107

Red Non-Stick Fuel Bowl Gasket

Part #

For Model 4500 Dominator HP three circuit carburetors.

2/pkg **108-107**

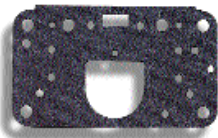

108-28-2

Metering Block Gasket

Part #

Primary metering block gasket for Model 4160 Chrysler applications beginning in 1968. Available in 2/pkg or bulk orders of 100 or more.

2/pkg **108-28-2**
100 or more **8R1906**



108-34-2

Metering Block Gasket

Part #

For Model 4160, list 0-6270-1 for 340 Chrysler. Available in 2/pkg or bulk orders of 100 or more.

2/pkg **108-34-2**
100 or more **8R1912**



108-35-2

Metering Block Gasket

Part #

For Model 2300, list 6425, 650 CFM two barrel. Available in 2/pkg or bulk orders of 100 or more.

2/pkg **108-35-2**
100 or more **8R1919**

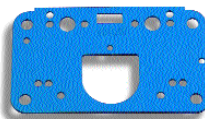

108-100

Metering Block Gasket

Part #

3-circuit Model 4150 competition carburetor

2/pkg **108-100**



Gaskets



108-55-2

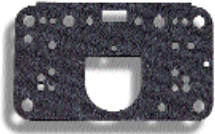

108-36-2

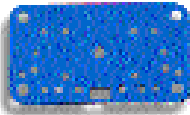

108-90-2



108-89-2

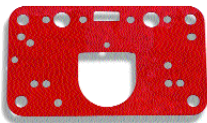

108-106

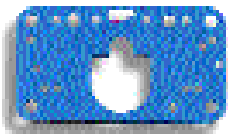

108-91-2

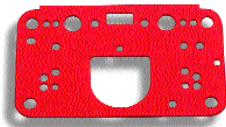

108-108

Metering Block Gasket

Primary and Secondary metering block gasket for Model 4500's with intermediate systems, such as list 6214 and 6464. Available in 2/pkg or bulk orders of 100 or more.

Part #

2/pkg **108-36-2**
100 or more **8R1923**

Metering Block Gasket

Primary metering block gasket for Model 4180. Available in 2/pkg or bulk orders of 100 or more.

Part #

2/pkg **108-55-2**
100 or more **8R1915**

Blue Non-Stick Metering Block Gasket

For most Model 4150's, some 4160's early 4165's and most 2300's. Secondary metering block gasket on double pumpers. Not used with accelerator pump transfer tube. Used on 4500's without intermediate idle system. Available in 2/pkg or bulk orders of 100 or more.

Part #

2/pkg **108-89-2**
100 or more **8R1907-1**

Blue Non-Stick Metering Block Gasket

Used as a secondary bowl and metering plate gasket on many 4160's and 4175's. Available in 2/pkg or bulk orders of 100 or more.

Part #

2/pkg **108-90-2**
100 or more **8R1908-1**

Blue Non-Stick Metering Block Gasket

Used as primary and secondary metering block gaskets on 4165/75 and a few 4150 carburetors. Used on primary side of some 4160's. Used on same carburetors as 108-29 when equipped with accelerator pump transfer tube. Not interchangeable with 8R1907 or 108-89-2. Available in 2/pkg or bulk orders of 100 or more.

Part #

2/pkg **108-91-2**
100 or more **8R1909-1**

Red Non-Stick Metering Block Gasket

For most Model 4150's, some 4160's early 4165's and most 2300's. Secondary metering block gasket on double pumpers. Not used with accelerator pump transfer tube. Used on 4500's without intermediate idle system.

Part #

2/pkg **108-106**

Red Non-Stick Metering Block Gasket

For Model 4500 Dominator HP three circuit carburetors.

Part #

2/pkg **108-108**

CARBURETORS

FUEL
MIXTURE

THROTTLE
BODIES

FUEL PUMPS

INTAKE
MANIFOLDS

SUPPLEMENTARY

CYLINDER
HEADS

SYSTEMS

WATER
PUMPS

DRESS-UP

BATTERY

STREET & TRUCK
ADAPTERS

POINT-OF-SALE

INDEX/
VARIANTS

Tech Line: 270-781-9741

49

Carburetors

Gaskets



108-200

These gasket assortments have been selected to cover popular Holley four barrels. Each contains the quantities of gaskets shown.

PART # 108-200	PART # 108-201	PART # 108-202	PART # 108-203
(2) 108-89	(1) 108-27	(1) 108-27	(2) 108-91
(2) 108-83	(1) 108-89	(1) 108-90	(2) 108-92
	(1) 108-90	(1) 108-91	
	(1) 108-83	(1) 108-92	

Fuel Bowl Gasket

Primary-bowl gasket for Model 4180. Available in 2/pkg or bulk orders of 100 or more.

Part #

2/pkg **108-56-2**

100 or more **8R1916**

Part #

Fuel Bowl Gasket

For computer controlled Model 4175. Primary bowl gasket for 4150/60 converted to Mile Dial Configuration. Primary and Secondary bowl gasket or 4150 converted to Quarter Mile Dial.

2/pkg **34-202**

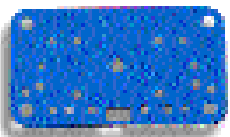
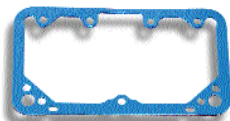

Fuel Bowl Screw and Gasket Kits

Part #

Primary Side (Models 4500, 4175, 4150, 4160)

26-124

Consists of:

- one (1) 8R1911-1 primary fuel bowl gasket for 2-circuit metering
- one (1) 8R1910-1 primary fuel bowl gasket models 4165 and 4175
- four (4) primary fuel bowl screws

Secondary Side (Models 4160 and 4175)

26-125

Consists of:

- one (1) 8R1908-1 secondary metering plate gasket
- four (4) secondary side fuel bowl screws

Secondary Side (Model 4165)

26-126

Consists of:

- one (1) 8R1908-1 secondary metering plate gasket
- one (1) 8R1910-1 primary fuel bowl gasket
- four (4) secondary side fuel bowl screws



108-27-2

Metering Plate Screws/Gaskets

Part #

This kit contains six (6) metering plate screws and one (1) each of the two styles of metering plate gaskets used in Holley 4160 and 4175 carburetors. They are also used on those model 2300 carburetors used on the outboard side of a tri-power set-up.

26-123



108-13-2

Secondary Metering Plate Gasket

Part #

For Some Model 4160s. Same pattern used on metal 1034-1993 metering body plate. Available in 2/pkg or bulk orders of 100 or more.

2/pkg **108-27-2**

100 or more **8R1899**

Secondary Metering Plate Gasket

Part #

For Model 4160 Chrysler and outboard Model 2300 on some 3 x 2 applications with diaphragm-operated throttles.

2/pkg **108-13-2**



Trick Kit®

- One kit services all Holley performance carburetors
- Uses genuine Holley quality service parts
- Extra parts provided for performance tuning
- Explicit step-by-step instructions
- Includes detailed tuning guide
- Packaging serves as a handy parts tray

37-933

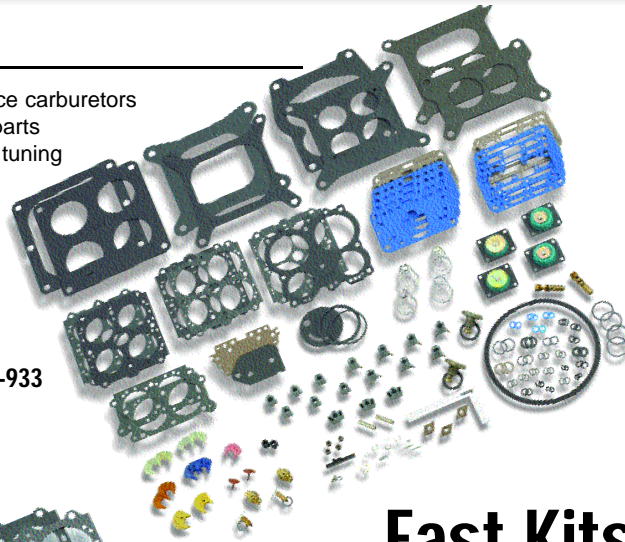

Fast Kits®

- Five kits service all Holley performance carburetors
- Uses genuine Holley quality service parts
- Explicit step-by-step instructions
- Includes detailed tuning guide
- Packaging serves as a handy parts tray
- Competitively priced

37-1542

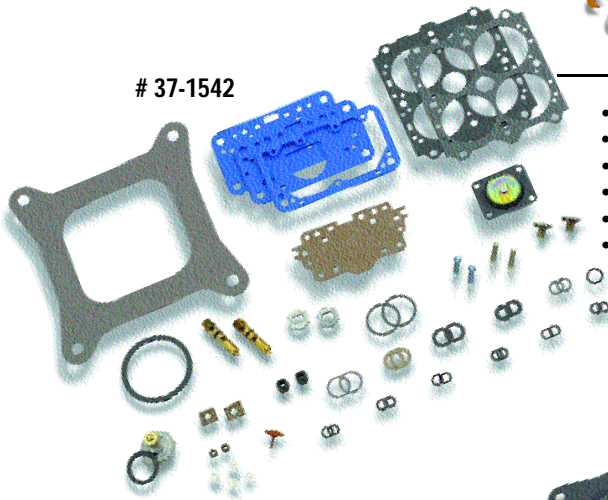

Renew Kits®

- Eleven kits service all Holley performance carburetors
- Uses genuine Holley quality service parts
- Explicit step-by-step instructions
- Includes detailed tuning guide
- Packaging serves as a handy parts tray
- Competitively priced

37-119



REAR SECTION
THROTTLE BODIES
FUEL PUMPS
INTAKE MANIFOLDS
SUPERSCHUBBERS
CYLINDER HEADS
SYMBAK
WATER PUMPS
DRESS-UP
BATTERY
STREET & TRUCK ADAPTERS
POINT-OF-SALE
INDEX / VARIANTS

Tech Line: 270-781-9741

Carburetors

HOLLEY TRICK KIT®

Part # **37-933**

When your Holley performance carburetor is due for a performance rebuild, it's time to get the Holley Trick Kit®. P/N 37-933. This Holley Trick Kit® contains all the parts that you'll need to perform a complete carburetor rebuild on your Holley vacuum secondary or double pump carburetor. Plus it's got extra parts related to carburetor calibration that are required to accomplish a real performance tune. These include accelerator pump discharge nozzles, accelerator pump cams, vacuum secondary springs and extra gaskets. A carburetor exploded view and a detailed tuning guide is also included. The packaging serves as a handy parts tray. This Holley Trick Kit® has it all.

R1848-1	R4055-1	R4742	R4779-5	R4801-1	R6708	R7054	R8181	R9776	R80166	R80514	R80708
R1849	R4056-1	R4776	R4779-6	R4802-1	R6708-1	R7154	R8276	R9834	R80169	R80519	R80781
R1850-2	R4118	R4776-1	R4779-7	R4803-1	R6709	R7320	R8302	R9834-1	R80186	R80528	R80783
R1850-3	R4144-1	R4776-2	R4779-8	R6109	R6710	R7320-1	R8546	R9834-2	R80186-1	R80528-1	R81850
R1850-4	R4224	R4776-3	R4780	R6129	R6711	R7351	R8679	R9837-3	R80431	R80529	R83310
R1850-5	R4235	R4776-4	R4780-1	R6210-1	R6772	R7397	R8700	R9895	R80432	R80529-1	R83310-1
R2818-1	R4236	R4776-5	R4780-2	R6210-2	R6773	R7410	R8804	R9923	R80436	R80531	R83311
R3124	R4295	R4776-6	R4780-3	R6210-3	R6774	R7411	R8879	R9948	R80450	R80532	R83312
R3247	R4296	R4777	R4780-4	R6211	R6853	R7413	R8896	R9976	R80452	R80533	R84412
R3310-1	R4346	R4777-1	R4780-5	R6211-1	R6895	R7448	R8896-1	R80095	R80453	R80535	R84776
R3310-2	R4365-1	R4777-2	R4780-6	R6212	R6909	R7855	R9002	R80098	R80454	R80535-1	R84777
R3310-3	R4412	R4777-3	R4781	R6213	R6910	R7985	R9040	R80099	R80457	R80540	R84778
R3310-4	R4412-1	R4777-4	R4781-1	R6238-1	R6919	R7986	R9188	R80111	R80457-1	R80541	R84779
R3310-5	R4412-2	R4777-5	R4781-2	R6239-1	66979	R7987	R9210	R80112	R80457-2	R80542	R84780
R3310-5	R4412-3	R4777-6	R4781-3	R6262	R6979-1	R8004	R9219	R80120	R80460	R80555	R84781
R3310-6	R4452-1	R4778	R4781-4	R6270-1	R6989	R8005	R9254	R80128	R80496	R80556	R87448
R3367	R4490	R4778-1	R4781-5	R6291	R7001	R8006	R9375	R80133	R80496-1	R80572	R89834
R3370	R4514-1	R4778-2	R4781-6	R6299-1	R7002-1	R8007	R9375-1	R80134	R80497	R80573	
R3418	R4548	R4778-3	R4781-7	R6464	R7004-1	R8059	R9377	R80135	R80498	R80574	
R3613	R4555	R4778-4	R4782	R6468-1	R7004-2	R8059-1	R9377-1	R80136	R80498-1	R80575	
R3659	R4575	R4778-5	R4783	R6468-2	R7005-1	R8060	R9377-2	R80137	R80507	R80576	
R3660	R4609	R4778-6	R4788	R6497	R7005-2	R8060-1	R9379	R80139	R80508	R80577	
R3807	R4628	R4779	R4788-1	R6498	R7006-1	R8082	R9380	R80145	R80508-1	R80578	
R3810	R4647	R4779-1	R4790	R6512	R7006-2	R8082-1	R9381	R80155	R80509	R80776	
R3811	R4653	R4779-2	R4791	R6520	R7009-1	R8082-2	R9645	R80163	R80511	R80777	
R3910	R4670	R4779-3	R4792	R6528	R7010	R8156	R9646	R80164	R80512	R80778	
R4053	R4672	R4779-4	R4800-1	R6619-1	R7053-1	R8162	R9647	R80165	R80513	R80779	

HOLLEY FAST KITS®

Five (5) Holley Fast Kits® cover the entire spectrum of Holley performance carburetors. Holley Fast Kits® include only genuine Holley parts and are also competitively priced. When your Holley is rebuilt using a genuine Holley Fast Kit®, you're assured that original Holley quality is being maintained. A handy parts package and detailed instructions are included.

37-1542 Fits model 4160			37-1543 Fits model 2300			37-1544 Fits model 4150			37-1546 Fits model 4150HP			37-1547 Fits model 4500		
R1848-1	R6946-1	R9776	R4412	R4295	R4779-4	R9380	R80496	R80540	R4575					
R1849	R6947	R9834	R4412-1	R4776	R4779-5	R9381	R80496-1	R80540-1	R6214					
R1851-2	R6979	R9834-1	R4412-2	R4776-1	R4779-6	R9645	R80497	R80541	R6464					
R1850-3	R6979-1	R9834-2	R4412-3	R4776-2	R4779-7	R9646	R80498	R80541-1	R7320					
R1850-4	R6989	R9834-3	R7448	R4776-3	R4779-8	R80572	R80498-1	R80542	R7320-1					
R1850-5	R7009-1	R50399	R9647	R4776-4	R4779-8	R80573	R80507	R80542-1	R8082					
R3310-2	R7053-1	R50399-1	R84412	R4776-5	R4780	R80574	R80507-1		R8082-1					
R3310-3	R7154	R80431	R87448	R4776-6	R4780-1	R80575	R80508		R8082-2					
R3310-4	R7413	R80432		R4777	R4780-2	R80576	R80508-1		R8896					
R3310-5	R7850	R80450		R4777-1	R4780-3	R80576	R80509		R8896-1					
R3310-6	R7985	R80451		R4777-2	R4780-4	R80577	R80509-1		R9375					
R3367	R7986	R80452		R4777-3	R4780-5	R80577	R80511		R9375-1					
R3370	R7987	R80453		R4777-4	R4780-6	R80776	R80511-1		R9377					
R3810	R8004	R80454		R4777-5	R4781	R80777	R80512		R9377-1					
R3811	R8005	R80457		R4777-6	R4781-1	R80778	R80513		R9377-2					
R4235	R8006	R80457-1		R4778	R4781-2	R80779	R80513-1		R80186					
R4236	R8007	R80457-2		R4778-1	R4781-3	R80780	R80514		R80186-1					
R4452-1	R8181	R80460		R4778-2	R4781-4	R80781	R80514-1		R80532					
R4548	R8207	R80551		R4778-3	R4781-5	R84776	R80519		R80532-1					
R6270-1	R8207	R81850		R4778-4	R4781-6	R84777	R80528		R80533					
R6291	R9002	R83310		R4778-5	R4781-7	R84778	R80528-1		R80533-1					
R6299-1	R9040	R83310-1		R4778-6	R6895	R84779	R80529		R80556					
R6520	R9210	R83311		R4779	R8156	R84780	R80529-1		R80556-1					
R6619-1	R9219	R83312		R4779-1	R8162	R84781	R80531		R80578					
R6909	R9254	R89834		R4779-2	R8804		R80535							
R6919	R9626			R4779-3	R9379		R80535-1							



HOLLEY RENEW KITS®

Purchase a Holley Renew Kit® next time a carburetor rebuild is due and you'll be assured of using only genuine Holley factory service parts. This really is the only sure way of knowing that your Holley carburetor will be brought back to original specifications and "like new" condition. The Renew Kit® package includes new gaskets, O-rings, pump diaphragm(s), needle and seat(s), power valve(s), and a detailed instruction sheet to take you step-by-step through the rebuilding process. All the parts and information necessary for a professional rebuild are included. Leave the "guessing" to others. Be assured with Holley brand Renew Kits.

37-119	37-474	37-485	37-605	37-720	37-754	37-1536	37-1537
R1848-1 R1849 R1850-2 R1850-3 R1850-4 R1850-5 R3367 R3370 R4452-1 R4548 R6291 R6520 R6909 R7053-1 R7154 R7413 R9040 R80431 R80432 R80457 R80457-1 R80457-2 R81850	R4412 R4412-1 R4412-2 R4412-3 R9011 R84412	R4235 R4780-3 R4236 R4780-4 R4295 R4780-5 R4296 R4780-6 R4776 R4781 R4776-1 R4781-2 R4776-2 R4781-3 R4776-3 R4781-4 R4776-4 R4781-5 R4776-5 R4781-6 R4776-6 R4781-7 R4777 R4788 R4777-1 R4788-1 R4777-2 R6109 R4777-3 R8156 R4777-4 R8162 R4777-5 R8804 R4777-6 R9022 R4778 R9379 R4778-1 R9380 R4778-2 R9381 R4778-3 R80427 R4778-4 R80537 R4778-5 R80776 R4778-6 R80777 R4779 R80778 R4779-1 R80779 R4779-2 R80780 R4779-3 R80781 R4779-4 R84476 R4779-5 R84777 R4779-6 R84778 R4779-7 R84779 R4779-8 R84780 R4780 R84781 R4780-1 R4780-2	R6210-1 R6210-2 R6210-3 R6211 R6211-1 R66262 R6468-1 R6468-2 R6497 R6498 R6512 R6528 R6711 R6772 R6773 R6774 R6853 R7054	R6619-1 R8007 R9013 R9015 R9834 R9834-1 R9834-2 R9834-3 R89834	R3310-2 R3310-3 R3310-4 R3310-4 R3310-5 R3310-6 R80508 R80508-1 R83310 R83310-1 R83311 R83312	R6270-1 R6895 R6919 R6989 R7009-1 R7410 R7411 R7448 R7985 R7986 R7987 R8004 R8005 R8006 R8181 R9002 R9210 R9219 R9254 R9647 R9776 R80095 R80098 R80099 R80111 R80112 R80120 R80133 R80134 R80135 R80136 R80137 R80163 R80164 R80165 R80166 R80450 R80451 R80452 R80453 R80454 R80460 R87448	R2818-1 R7004-2 R3659 R7005-1 R3660 R7005-2 R3807 R7006-1 R3810 R7006-2 R3811 R7010 R4055-1 R7351 R4056-1 R7397 R4144-1 R7855 R4224 R8059 R4365-1 R8059-1 R4514-1 R8060 R4609 R8060-1 R4628 R8276 R4647 R8302 R4653 R8546 R4670 R8679 R4672 R8700 R4782 R8879 R4783 R9023 R4790 R9895 R4791 R9923 R4792 R9948 R6105 R9976 R6105-1 R80128 R6106 R80139 R6107 R80155 R6107-1 R80169 R6129 R80491 R6212 R80555 R6213 R6499 R6710 R6910 R7002-1 R7004-1
37-1539	R3124 R9377-2 R3247 R9645 R3310-1 R9646 R3418 R75010 R3613 R75011 R3910 R80145 R4053 R80159 R4118 R80186 R4346 R80186-1 R4490 R80340 R4555 R80340-1 R4575 R80436 R4742 R80496 R4800-1 R80496-1 R4801-1 R80497 R4802-1 R80498 R4803-1 R80498-1 R6238-1 R80507 R6239-1 R80509 R6299-1 R80511 R6464 R80512 R6708 R80513 R6708-1 R80514 R6709 R80519 R7320 R80528 R7320-1 R80528-1 R8082 R80529 R8082-1 R80529-1 R8082-2 R80531 R8572 R80532 R8896 R80533 R8896-1 R80535 R9029 R80535-1 R9188 R80540 R9375 R80541 R9375-1 R80542 R9377 R80556 R9377-1	R7454 R7455 R7456 R7555 R7556 R7955 R7956 R7957 R7958 R8001 R8002 R8003 R8149 R8149-1 R8158 R8203 R8204 R8206 R8479 R8516 R8517 R8642 R8677 R8771 R8874 R8914 R8958 R9112 R9162 R9185 R9192 R9193 R9694 R9777 R9931 R9935 R9973	37-1540 R7454 R7455 R7456 R7555 R7556 R7955 R7956 R7957 R7958 R8001 R8002 R8003 R8149 R8149-1 R8158 R8203 R8204 R8206 R8479 R8516 R8517 R8642 R8677 R8771 R8874 R8914 R8958 R9112 R9162 R9185 R9192 R9193 R9694 R9777 R9931 R9935 R9973	37-1541 R82010 R84020 R82011 R84020-1 R82012 R84020-2 R84010 R84020-3 R84010-1 R84021 R84010-2 R84021-1 R84010-3 R84021-2 R84011 R84021-3 R84011-1 R84022 R84011-2 R84022-1 R84011-3 R84023 R84012 R84023-1 R84012-1 R84023-2 R84012-2 R84024 R84012-3 R84024-1 R84013 R84026 R84013-1 R84026-1 R84013-2 R84026-2 R84013-3 R84028 R84014 R84035 R84014-1 R84035-1 R84014-2 R84035-2 R84014-3 R84038 R84015 R84039 R84015-1 R84040 R84015-2 R84040-1 R84015-3 R84041 R84016 R84041-1 R84016-1 R84042 R84016-2 R84044 R84016-3 R84044-1 R84017 R84047 R84017-1 R84047-1 R84018 R84018-1 R84018-2			

- CRACKERS
- FUEL METERING
- THROTTLE BODIES
- FUEL PUMPS
- INTAKE MANIFOLDS
- SPRINGS
- CYLINDER HEADS
- SYSTEMS
- WATER PUMPS
- DRESS-UP
- BATTERY
- STREET & TRUCK ADAPTERS
- PAINTS/SEALERS
- INDEX/WARRANTY

Tech Line: 270-781-9741

Carburetors

Carburetor Metering Jets



Emulsion Jets

(6/32 UNF Thread)

P/N	Hole Size
142-00	.000"
142-20	.020"
142-21	.021"
142-22	.0225"
142-24	.024"
142-25	.025"
142-26	.026"
142-28	.028"
142-29	.0292"
142-31	.031"
142-32	.032"
142-33	.033"
142-35	.035"
142-36	.036"
142-37	.037"
142-38	.038"
142-39	.039"
142-40	.040"
142-41	.041"
142-42	.042"
142-43	.043"
142-46	.0465"
142-52	.052"
142-55	.055"
142-59	.0595"
142-62	.0625"
142-64	.0635"
142-67	.067"
142-70	.070"
142-73	.073"
142-76	.076"
142-78	.078"



Standard Main Jets

(1/4-32 UNF Thread)

P/N	Hole Size	P/N	Hole Size
122-40	.040"	122-78	.0870"
122-41	.041"	122-79	.0890"
122-42	.042"	122-80	.0890"
122-43	.043"	122-81	.0920"
122-44	.044"	122-82	.0940"
122-45	.045"	122-83	.0975"
122-46	.0465"	122-85	.0985"
122-47	.047"	122-86	.1000"
122-48	.048"	122-87	.1015"
122-49	.048"	122-88	.1025"
122-50	.049"	122-89	.1045"
122-51	.050"	122-90	.1055"
122-52	.052"	122-91	.1085"
122-53	.052"	122-92	.1100"
122-54	.053"	122-93	.1125"
122-55	.054"	122-94	.1155"
122-56	.055"	122-95	.1165"
122-57	.056"	122-96	.1195"
122-58	.057"	122-97	.1210"
122-59	.058"	122-98	.1240"
122-60	.060"	122-99	.1260"
122-61	.060"	122-100	.1285"
122-62	.061"	122-101	.1260"
122-63	.062"	122-102	.1280"
122-64	.064"	122-103	.1300"
122-65	.065"	122-104	.1340"
122-66	.066"	122-105	.1370"
122-67		122-106	.1410"
122-68		122-107	.1450"
122-69		122-108	.1470"
122-70	.0735"	122-109	.1500"
122-71	.0750"	122-110	.1560"
122-72	.0755"		
122-73	.0790"		
122-74	.0800"		
122-75	.0820"		
122-76	.0840"		
122-77	.0855"		



Carburetor Metering Jets

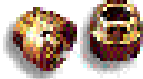

Alcohol Jets

5/6-32 UNFthread

Holley alcohol jets are specially designed to work only with the following model 4150 HP carburetors: 0-80542 (650 CFM), 0-80535 (750 CFM) and 0-80498 (950 CFM). The unique metering blocks used with these carburetors are designed to accept the physically larger size of this main jet.

There are ten (10) jets per package. The following sizes are available:

STANDARD LENGTH		EXTENDED LENGTH	DRILLSIZE
JETNO.	JETNO.	JETNO.	
122-132	122-1132		.132
122-136	122-1136		.136
122-138	122-1138		.138
122-140	122-1140		.140
122-142	122-1142		.142
122-144	122-1144		.144
122-146	122-1146		.146
122-148	122-1148		.148
122-150	122-1150		.150
122-152	122-1152		.152
122-154	122-1154		.154
122-156	122-1156		.156
122-158	122-1158		.158
122-160	122-1160		.160
122-164	122-1164		.164
122-168	122-1168		.168
122-172	122-1172		.172
122-176	122-1176		.176
122-180	122-1180		.180
122-184	122-1184		.184
122-188	122-1188		.188
122-192	122-1192		.192
122-196	122-1196		.196
122-200	122-1200		.200

NOTE: Alcohol jet kits are available. A selection of alcohol jet sizes can be ordered under P/N 36-201.

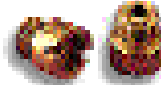

Close Limit Jets

1/4-32 UNFthread

Holley close limit jets originally were developed for OEM applications to obtain tighter carburetor emission flow limits. Jet numbering follows that of the standard jets, except that a third number is added. For example, a jet stamped with part number "632" indicates that this is a #63 jet. The third number (in this instance "2") is added to indicate whether the jet flows on the lean side (631), the middle (632) or rich side (633) of the flow band. There is about a 1.5% difference in flow between each of the three jets in a flow band, for a flow range difference of 4.5%. There are two (2) jets per package. The following sizes are available:

JET NO.

122-602
122-612
122-622
122-632
122-642
122-652
122-662
122-672
122-682
122-692
122-702
122-712
122-722
122-732
122-742

CARBURETORS

FUEL METERING

THROTTLE BODIES

FUEL PUMPS

INTAKE MANIFOLDS

SUPERCARGERS

CYLINDER HEADS

SYMBARK

WATER PUMPS

DRESS-UP

BATTERY

STREET & TRUCK ADAPTERS

POINT-OF-SALE

NAME/ VARIANTS

Tech Line: 270-781-9741

55

Carburetors

Air Bleeds

Models 4150 and 4500 DOMINATOR HP

Replaceable air bleeds for the idle, intermediate and high speed circuits. All bleeds are #10-32 UNF thread. Note: the "-10" indicates a quantity of ten (10) bleeds per package.



Air Bleed	Drill Size	Air Bleed	Drill Size
126-23-10	.023	126-47-10	.047
126-24-10	.024	126-49-10	.049
126-25-10	.025	126-51-10	.051
126-26-10	.026	126-53-10	.053
126-27-10	.027	126-55-10	.055
126-28-10	.028	126-57-10	.057
126-29-10	.029	126-59-10	.059
126-30-10	.030	126-61-10	.061
126-31-10	.031	126-63-10	.063
126-32-10	.032	126-65-10	.065
126-33-10	.033	126-67-10	.067
126-34-10	.034	126-69-10	.069
126-35-10	.035	126-70-10	.070
126-36-10	.036	126-71-10	.071
126-37-10	.037	126-72-10	.072
126-38-10	.038	126-73-10	.073
126-39-10	.039	126-74-10	.074
126-40-10	.040	126-75-10	.075
126-41-10	.041	126-76-10	.076
126-43-10	.043	126-77-10	.077
126-45-10	.045	126-78-10	.078

Air Bleed Specifications 4150 HP and 4500 DOMINATOR HP

CARBURETOR LIST NO.	IDLE BLEED	INTERMEDIATE BLEED	MAIN BLEED
R7320-1	53	N/A	28
R8082-2	71	N/A	37
R8896-1	53	63	40
R9375	39	N/A	25
R9375-1	53	63	34
R9377-1	40	61	28
R75010	40	61	33
R75011	49	61	28
R80186-1	73	N/A	36
R80340-1	71	N/A	34
R80496	72	N/A	32
R80498	55	N/A	30
R80507	73	N/A	OPEN CHANNEL
R80509	72	N/A	32
R80511	73	N/A	33
R80513	75	N/A	25
R80514	73	N/A	32
R80528-1	75	N/A	36
R80529-1	72	N/A	32
R80532	51	61	28
R80533	53	65	36
R80535-1	61	N/A	31
R80540	74	N/A	45
R80541	72	N/A	45
R80542	59	N/A	33
R80556	51	59	31
R80586	28	54	28
R80785	72	N/A	32



Air Bleed Assortment Kit

Part # **36-240^(B)**

4500 DOMINATOR HP and 4150 HP Carburetors

This air bleed kit is a must when track-tuning a 4500 DOMINATOR HP carburetor for maximum performance. The kit includes four (4) of each air bleed size from #20 to #79. All bleeds are #10-32 UNF thread. Air bleeds are contained in a plastic case that is designed to keep them separated and make them easily accessible.



Jet Assortment Kit

Part # **36-181**^(B)

Holley 2-bbl and 4-bbl Performance Carburetors

The Holley jet assortment kit is the professional way to track-tune your Holley carburetor for top performance. This kit consists of two (2) each of thirty-six (36) different jet sizes, ranging from #64 to #99. The jets are contained in a plastic case that is designed to keep them separated and make them easily accessible. Jet sizes selected will give the broadest range of adjustment and tuning for most performance carburetor applications.

NEW!



Emulsion Bleed Kit

Part # **36-322**^(B)

This kit contains a selection of emulsion bleeds that can be used for tuning the 0-80507-2 carburetor. It consist of the following:

Description	Qty
Emulsion Jet Blank	10
Emulsion Jet 0.020	10
Emulsion Jet 0.031	10
Emulsion Jet 0.040	10
Emulsion Jet 0.046	10
Emulsion Jet 0.052	10

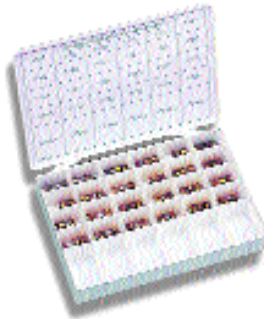

Alcohol Jet Kit

Part # **36-201**^(B)

This Holley jet assortment kit consists of 4 EA. of 24 standard length jets that range in size from .132" to .200". These jets will not fit the standard Holley metering block; they are designed to fit only the 750 and 950 CFM HP and 0-80586 HP DOMINATOR alcohol carburetors featured elsewhere in this catalog. The assortment is packaged in a durable plastic carrying case.

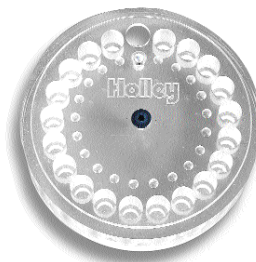

Jet Holder Kit

Part # **20-111**

The handy way to keep your jets organized. The Holley Jet Holder contains twenty (20) individual compartments that can hold two (2) jets. Therefore twenty (20) different jet sizes can be conveniently held for immediate access. The rotating top prevents spillage and the clear plastic allows for easy viewing.

- CARBURETORS
- FUEL METERING
- THROTTLE BODIES
- FUEL PUMPS
- INTAKE MANIFOLDS
- SUPPUBBERS
- CYLINDER HEADS
- SYSTEMS
- WATER PUMPS
- DRESS-UP
- BATTERY
- STREET & TRUCK ADAPTERS
- PUMP-UP-SIDE
- INDEX/ALPHABETIC

Tech Line: 270-781-9741

Carburetors

Metering Plates

Many Holley performance carburetors use a secondary metering plate, with drilled restrictions, rather than a secondary metering block, with removable jets. When recalibrating the secondary side on such a carburetor a change of the secondary metering plate is required.

The picture, below, shows a typical secondary metering plate. Noted are the secondary idle feeds (Hole "B") and the secondary main metering restrictions (Hole "A"). These, in turn, relate to the chart with which the metering plate specifications can be determined.

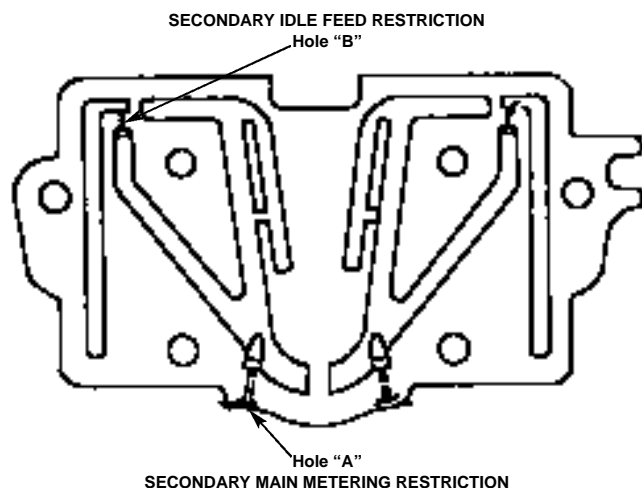

Holley Secondary Metering Plates

MAIN HOLE "A"	IDLE HOLE "B"	HOLLEY P/N	PART STAMPED
.052	.029	34R9716-34	34
.055	.026	34R9716-3	3
.059	.029	34R9716-32	32
.067	.026	134-8	8
.067	.031	134-9	9
.070	.026	34R9716-6	6
.073	.029	134-39	39
.073	.031	134-37	37
.076	.028	34R9716-22	22
.076	.031	34R9716-12	12
.076	.035	34R5113-3	3
.081	.040	134-21	21
.089	.040	34R9716-27	27
.096	.040	34R9716-45	45

Metering-Plate-to-Main-Jet Correlation Chart

The chart below can be used as a guide when correlating main metering jet part numbers to secondary metering plates. This is necessary when converting the secondary metering plate to a metering block, with replaceable jets, as with the conversion kits listed above.

SECONDARY METERING PLATE PART #	EQUIVALENT MAIN JET PART #
134-8	122-64
134-9	122-64
134-21	122-75
134-37	122-69
134-39	122-69
34R5113-3	122-65
34R9716-3	122-56
34R9716-6	122-69
34R9716-12	122-73
34R9716-22	122-65
34R9716-27	122-79
34R9716-32	122-59
34R9716-34	122-53
34R9716-45	122-79
34R9716-54	122-75



CARBURETOR METERING BLOCK SERVICE PARTS



Idle Mixture Screw

Accessible, large head style

Part #

26-101



Idle Mixture Screw Gasket

Replacement cork gasket (Pkg. 10)

26-110-10

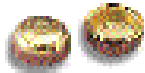

Metering Block Plugs

Main well plugs (Pkg. 10)

26-111-10



Main Jet Extensions

An improved jet extension design that actually screws into the metering block. The main metering jet then threads into the end of the extension. The installation effectively moves the fuel entry point for the main jet out into the fuel bowl. In this location it cannot be uncovered by fuel, causing a lean condition, during periods of hard acceleration or braking. 2/Pkg.

122-5000

WARNING: Requires the use of special "notched" floats to achieve proper clearance and enable the float to operate normally.



34-6

Metering Blocks

Model 4160 to 4150 Conversion Kits

NOTE: Illustrated is a typical kit. Fuel bowls are not included and the metering block has no provision for a power valve. Both a "shiny finish" and a "standard finish" are available as denoted below.

PART #	FINISH	APPLICATION
34-6	standard	0-1850 or most any model 4160 with side hung float bowls
34-6S	shiny	0-1850S & 0-80457S
34-13	standard	0-3310 or most any model 4160 with center hung float bowls
34-13S	shiny	0-3310S & 0-80508S

CARBURETORS

FUEL METERING

THROTTLE BODIES

FUEL PUMPS

INTAKE MANIFOLDS

SUPPLEMENTARY

CYLINDER HEADS

SPARK

WATER PUMPS

DRESS-UP

BATTERY

STREET & TRUCK ADAPTERS

POINT-OF-SALE

INDEX / WARRANTY

Tech Line: 270-781-9741

59

Carburetors

Needle & Seat Assemblies

Holley offers a number of needle and seat assemblies for its carburetors. The configuration of the needle and seat assembly and its seat size depend on carburetor application, CFM size and type of fuel bowl used. Operation is simple. Needle movement is controlled by a metal tang on the float arm. Upward movement of the float causes the needle to close the seat; downward float movement causes the needle to open the seat. Seat size determines how much fuel can flow at a certain pressure. A bigger seat size will flow more fuel; a smaller seat size will flow less fuel at a given pressure.

"Viton" Inlet Needles

Most Holley performance carburetors come equipped with a Viton-tipped needle. The Viton needle design is resistant to dirt and conforms nicely to the shape of the seat for superior sealing. For this reason it is not recommended to use a steel or titanium needle, except for racing.

SEAT SIZE	TYPE*	PART#
.097"	Adjustable	6-506
.097"	Adjustable	6-508
.097"	Adjustable	6-517
.110"	Adjustable	6-504
.120"	Adjustable	6-518-2
.101"	Adjustable	6-520
.0785"	Non-Adjustable	6-511
.110"	Non-Adjustable	6-510
.097"	Off-Road	6-513

"Titanium" Inlet Needle

With a .150" seat, this needle and seat assembly **6-521** is about as big as you can get. What's really trick, though, is that the needle is made of titanium! This needle design is very responsive to changes in flow rates and has excellent sealing capabilities.

"Steel" Inlet Needles

"Steel-tipped" inlet needles are necessary when using exotic racing fuels or alcohol or when using benzine or acetone additives. A .097" seat size should be used for small four barrel carburetors; a .110" seat size should be used for carburetors up to 735 CFM; larger seat sizes should be used with carburetors 750 CFM and larger. The following steel inlet needle and seat assemblies are available from Holley.

SEAT SIZE	TYPE*	PART#
.097"	Adjustable	6-501-2
.110"	Adjustable	6-500-2
.120"	Adjustable	6-502-2
.130"	Adjustable	6-515-2
.150"	Adjustable	6-519-2

* "Type" refers to the needle and seat design. The "adjustable" needle and seat design allows external float adjustment, without removing the fuel bowl. The "non-adjustable" needle and seat design does not provide for external float adjustment. The fuel bowl must be removed for this procedure. All Holley model 2010, 2300, 4010, 4011, 4150, 4160, 4165, 4175 and 4500 DOMINATOR carburetors will take either one version or the other. Center hung fuel bowls use only the "adjustable" style needle and seat, as do all model 2010, 4010, 4011 and 4500 DOMINATOR carburetors. Side hung fuel bowls have come in a variety of styles over the years and have used both the "adjustable" and "non-adjustable" styles needle and seats.

Adjustable Needle and Seat Hardware Kit Part # **34-7**

This Kit contains:

- 1 EA Adjusting nut with gasket
- 1 EA Locking screw with gasket
- 1 EA O-ring



34-7



The Truth About The Power Valve

The power valve is a key component of the power enrichment system of Holley performance carburetors. The power enrichment system supplies additional fuel to the main system during heavy load or full power situations. Holley utilizes a vacuum operated power enrichment system and a selection of power valves is available to "time" this system's operation to your specific requirements.

Each Holley power valve is stamped with a number to indicate its vacuum opening point. For example, the number "65" indicates that the power valve will open when the engine vacuum drops to 6.5" Hg, or below.

An accurate vacuum gauge, such as Holley P/N 26-501, should be used when determining the correct power valve to use.

A competition or race engine which has installed a long duration, high overlap cam will have low manifold vacuum at idle speeds. If the vehicle has a manual transmission, take the vacuum reading with the engine thoroughly warmed up and at idle. If the vehicle is equipped with an automatic transmission, take the vacuum reading with the engine thoroughly warmed up and idling in gear. In either case, the power valve selected should have a vacuum opening point about 2" Hg below the intake manifold vacuum reading taken.

A stock engine, or one that is only mildly built for street use, will have high manifold vacuum (17" to 21" Hg) at idle speeds. To determine the correct power valve, the vehicle should be driven at various steady speeds and vacuum readings taken. The power valve selected should have an opening point about 2" Hg below the lowest steady speed engine vacuum observed. Holley has a 6.5" Hg power valve, P/N 125-65, which usually works out well for most driving situations.

Since 1992, many of the new Holley performance carburetors built today now incorporate "power valve blow-out protection". With this provision, the power valve diaphragm is protected from damage due to engine backfire, by a check valve that is located in the throttle body. This check valve is designed to be normally open but quickly seals to close off the internal vacuum passage if a backfire occurs. Once closed, the check valve interrupts the pressure wave generated by the backfire, thus protecting the power valve diaphragm.

POWER VALVE IDENTIFICATION

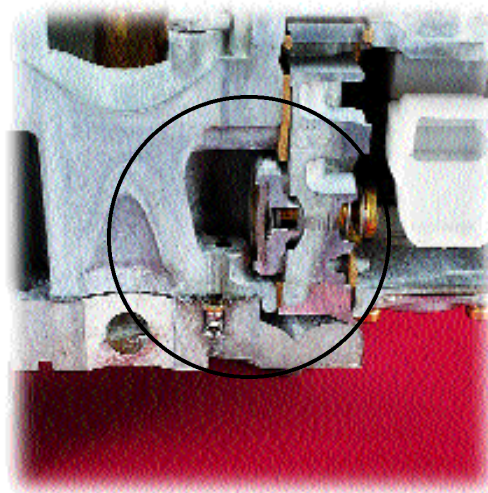
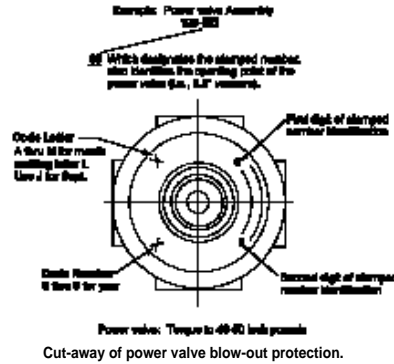

TECH TIP

Power Valves and Carburetors for Superchargers

Holley carburetors that are intended for use with superchargers, have a unique capability that allows their power valves to reference the intake manifold vacuum below the supercharger. This allows the power valve to operate as it should, based off intake manifold vacuum. A power valve provides further enrichment to the main metering system under load (low vacuum) conditions. Without this external referencing, the power valve would be "reading" the supercharger boost pressure, which has no bearing on the engine load.

CARBURETORS

FUEL
MIXTURE

THROTTLE
BODIES

FUEL
PUMP

INTAKE
MANIFOLDS

SUPERCHARGERS

CYLINDER
HEADS

SPARK
PLUGS

WATER
PUMPS

DRESS-UP

BATTERY

STREET & TRUCK
ADAPTERS

POINT-OF-SALE

MAINT/
WARRANTY

Tech Line: 270-781-9741

61

Carburetors

Power Valves

Single-Stage (includes gasket)

PART #	OPENING VACUUM
Standard Flow	
125-10	1.0" Hg
125-25	2.5" Hg
125-35	3.5" Hg
125-45	4.5" Hg
125-50	5.0" Hg
125-55	5.5" Hg
125-65	6.5" Hg
125-75	7.5" Hg
125-85	8.5" Hg
125-95	9.5" Hg
125-105	10.5" Hg
High Flow	
125-125	2.5" Hg
125-135	3.5" Hg
125-145	4.5" Hg
125-155	5.5" Hg
125-165	6.5" Hg
125-185	8.5" Hg
125-1005	10.5" Hg



125-65

Two-Stage* (includes gasket)

PART #	1ST STAGE OPENING	2ND STAGE OPENING
Model 4160		
125-206	12.5" Hg	5.5" Hg
125-207	10.5" Hg	5.0" Hg
125-208	10.5" Hg	5.5" Hg
125-213	11.5" Hg	5.0" Hg
Model 4175		
125-209	11.0" Hg	6.0" Hg
125-210	9.0" Hg	2.5" Hg
125-211	10.5" Hg	5.5" Hg
125-212	12.0" Hg	6.5" Hg
125-215	10.0" Hg	6.0" Hg
125-216	8.0" Hg	1.5" Hg

* Two-stage power valves ARE NOT RECOMMENDED for performance applications.

Power Valve Check Ball Kit

Part # **125-500**

Power valve "blowout" protection can now be added to pre '92 model 2300, 4150 and 4160 carburetors. Consisting of a spring, brass seat and check ball, this kit will effectively protect the power valve and is easy to install. Included is the proper drill bit size, with stop, to facilitate installation. Detailed instructions are included.



125-500

Power Valve Plug and Gasket

Part # **26-36**

Racers sometimes will prefer to run without a power valve. In these cases a power valve plug must be used to block the power valve circuit. Furthermore, jet sizes must be increased to compensate for loss of the fuel enrichment provided by the power valve. An increase of 6 to 8 jet sizes will, in most cases, be enough compensation. It's advisable, however, to "read" the spark plugs and verify proper jetting. Power Valve Thread: 1/2-28



26-36



Accelerator Pump Cam

Part # **20-80**



"White" pump cam for model 4500 DOMINATOR carburetors. Profile design gives a quick, early shot of fuel but it does not empty the pump.

Accelerator Pump Cam

Part # **20-81**

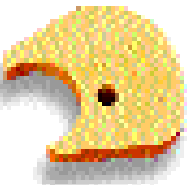

"Yellow" pump cam for model 4500 DOMINATOR carburetors. Profile design delivers an early fuel shot and continues until the pump empties.

Accelerator Pump Cam Assortment Kit

Part # **20-12**



Another great tuning kit from Holley. This one will allow you to "tailor" accelerator pump performance to the engine's actual requirements. Each cam has a different shape or profile to give different results. Cam "lift" directly affects the accelerator pump stroke and, therefore, pump capacity. Ramp profile or shape controls the "timing" of the shot. A steeply-rising ramp shape will give a fast, heavy fuel shot right off idle. Conversely, a gently sloping ramp will spread the pump action over a longer period of time.

Accelerator Pump Conversion Kit - 50cc

Part # **20-11**

Models 2300, 4150 and 4160



Instantaneous response! Pull strongly throughout the RPM band! A "must" for tunnel ram setups! This kit is for those who demand ultimate performance from their Holley carburetor(s). The Holley 50cc accelerator pump will substantially increase fuel capacity over the standard 30cc pump system. Eliminates flat spots off idle or at any other RPM range. This kit includes everything required for easy installation including new pump housing, stud, arm, diaphragm, spring and longer pump housing screws.

CHROMIUM
FUEL METERING
THROTTLE BODIES
FUEL PUMPS
INTAKE MANIFOLDS
SUPPLEMENTARY
CYLINDER HEADS
SYSTEMS
WATER PUMPS
DRESS-UP
BATTERY
STREET & TRUCK ADAPTERS
POINT-OF-SALE
INDEX/ALPHABETIC

Tech Line: 270-781-9741

63

Carburetors

Accelerator Pump

	Part #
Transfer Tube	26-23
Transfer Tube O-Ring	26-38



26-23



26-38

Accelerator Pump Spring

	Part #
30cc	20-108-10
50cc	20-109-10



20-108-10



20-109-10

"Umbrella" Check Valve

	Part #
	26-41



26-41



135-5

Diaphragms

	Part #
30cc (rubber) w/o screws	135-5
30cc (rubber) w/ screws	135-12
30cc (GFLT)* w/o screws	135-10
50cc (rubber) w/o screws	135-7
50cc (rubber) w/ screws	135-14
50cc (GFLT)* w/o screws	135-9
50cc (GFLT)* w/ screws	135-15



135-7



135-9

Pump arm

	Part #
Models 2300, 4150, 4160 (plastic)	20-78
30cc pump arm (metal)	20-114

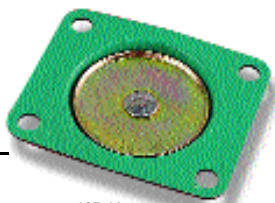

135-10



20-78

Pump cup/stem

	Part #
Model 4360	135-1



135-1



34-504

Pump cover - chrome

	Part #
30cc pump	34-504
50cc pump	34-505



ACCELERATOR PUMP DISCHARGE NOZZLES

A good selection of accelerator pump discharge nozzle sizes is indispensable to the proper tuning of the accelerator pump system. The nozzle hole size determines the rate of fuel discharge. A larger hole will "shoot" the fuel at a faster rate, and with less pressure, than a smaller hole. Sizes are stamped on each nozzle. For example, the number "31" indicates that the nozzle hole size is .031". Various styles of nozzles are offered by Holley, including the following:

NOTE: Nozzle sizes .040" and larger include a hollow nozzle screw.

Straight Type

(includes 2 gaskets)

Used on Models
4150, 4160 and 4500

PART #	HOLE SIZE
121-118	.018
121-121	.021
121-125	.025
121-128	.028
121-131	.031
121-132	.032
121-135	.035
121-137	.037
121-140	.040
121-142	.042
121-145	.045
121-147	.047
121-150	.050



121-131

Anti-Pullover Style

(includes 2 gaskets)

Originally used on
Models 4165 and 4175

The anti-pullover nozzle can be used on other models as well. This style was designed to combat the condition that's sometimes called "pump pull-over". That is, as the stream of air rushes past the pump discharge nozzle it has the tendency to "pull" the fuel from the nozzle. The following anti-pullover styles are available:

PART #	HOLE SIZE
121-225	.025
121-228	.028
121-231	.031
121-237	.037
121-240	.040



121-231

Tube Type

(includes 2 gaskets)

Used on Models
4150, 4160 and 4500

PART #	HOLE SIZE
121-25	.025
121-28	.028
121-31	.031
121-35	.035
121-37	.037
121-40	.040
121-42	.042
121-45	.045



121-40

Accelerator Pump Tuning Kit

Part #

36-184(B)

Contains a selection of accelerator pump hardware components including pump diaphragms, pump nozzles, pump cams and related parts. For Holley 2-bbl and 4-bbl performance carburetors. See "Kits and Assortments" page in this section for details.

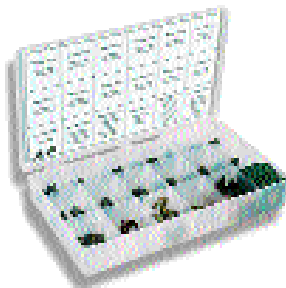

Center Squirter Nozzle

(Used on 0-4224)

PART #	Hole Size
121-325 (includes 2 gaskets)	.025

Center Squirter Nozzle Gasket

PART #	Quantity
1008-844	10/Pkg.

(B) Not legal for sale or use in California on any pollution controlled motor vehicles.

Tech Line: 270-781-9741

65

CARBURETORS

FUEL
METERING

THROTTLE
BODIES

FUEL PUMPS

INTAKE
MANIFOLDS

SUPPLEMENTARY
SYSTEMS

CYLINDER
HEADS

SYSTEMS

WATER
PUMPS

DRESS-UP

BATTERY

STREET & TRUCK
ADAPTERS

POINT-OF-SALE

MAINT/
DIAGNOSTIC

Carburetors

Float Kits

Floats for Holley 2-bbl and 4-bbl performance carburetors come in two basic designs: side hung and center hung. A "side hung float" is so-called because the float arm is attached to the side of the float and it's hung or pivoted from the side of the float bowl. A "center hung float" has its float arm attached to the float center and it's hung or pivoted from the center of the float bowl.

The float material used in any particular carburetor is very often dependent on the carburetor usage. For example, carburetors designed to run on alcohol must use a brass float; carburetors set up for "blow-through" forced induction systems need to use nitrophenyl floats; carburetors used on a "draw-through" forced induction system could use either a brass or a nitrophenyl float. Today, Holley float designs are manufactured in only brass or nitrophenyl, and they are interchangeable.

Most Holley performance carburetors have externally-adjustable floats. This feature greatly facilitates one's ability to help keep the carburetor in perfect tune.

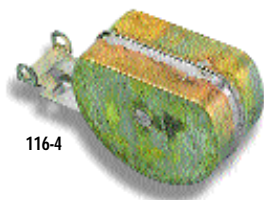

116-4

Side Hung Float

Part #

Nitrophenyl **116-1**
Brass **116-4**

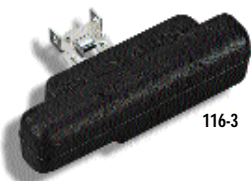

116-3

Center Hung Float

Part #

Brass **116-2**
Nitrophenyl **116-3**

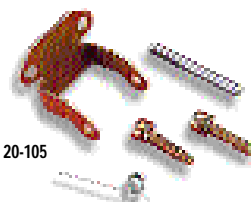

20-105

Float Hanger Hardware Kit

Part #

Includes fuel bowl hardware for float installation

20-105

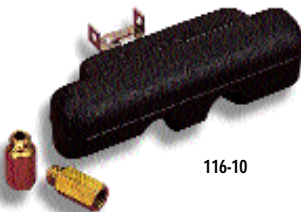

116-10

Notched Float Kits

Part #

A notched float is an absolute necessity when using main jet extensions! This factory, center hung nitrophenyl float is designed with "notches" to clear main jet extensions. This allows the float to operate normally without the possibility of interference from the extensions.

Notched float with two main jet extensions

116-10

Notched float without main jet extensions

116-11



Vacuum Secondary Diaphragms

Carburetor number	Diaphragm	Carburetor number	Diaphragm	Carburetor number	Diaphragm	Carburetor number	Diaphragm
R1848-1	135-2	R4789	135-6	R8207	135-4	R80164	135-4
R1849	135-4	R4790	135-6	R8276	135-4	R80165	135-4
R1850(ALL)	135-4	R6127	135-3	R8302	135-4	R80166	135-4
R2929	135-3	R6128	135-3	R8546	135-4	R80169	135-4
R2953-1	135-3	R6129	135-3	R8679	135-4	R80431	135-4
R2973	135-3	R6291-1	135-4	R8700	135-4	R80432	135-4
R3116	135-3	R6299-1	135-2	R8879	135-4	R80436	135-4
R3220	135-2	R6520	135-4	R9002	135-4	R80450	135-4
R3259-1	135-3	R6619	135-4	R9040	135-4	R80451	135-4
R3300	135-3	R6909	135-4	R9188	135-4	R80452	135-4
R3301	135-3	R6919	135-4	R9219	135-4	R80453	135-4
R3310(ALL)	135-4	R6979	135-4	R9210	135-4	R80454	135-4
R3410	135-3	R6989	135-4	R9626	135-4	R80457	135-4
R3411	135-3	R7002	135-4	R9834	135-4	R80460	135-4
R3418-1	135-3	R7004	135-4	R9895	135-4	R80476	135-4
R3659	135-6	R7005	135-4	R9923	135-4	R80491	135-4
R3977	135-3	R7006	135-4	R9948	135-4	R80497	135-3
R4118	135-3	R7009	135-4	R9976	135-4	R80508	135-4
R4168	135-3	R7010	135-4	R80073	135-4	R80512	135-3
R4174	135-3	R7053-1	135-4	R80098	135-4	R80519	135-3
R4201	135-3	R7154	135-4	R80099	135-4	R80529	135-3
R4202	135-3	R7351	135-4	R80111	135-4	R81850	135-4
R4235	135-3	R7397	135-4	R80112	135-4	R83310	135-4
R4236	135-3	R7855	135-4	R80128	135-4	R83311	135-4
R4279	135-3	R7985	135-4	R80133	135-4	R83312	135-4
R4280	135-3	R7986	135-4	R80134	135-4	R84010	135-4
R4365-1	135-6	R7987	135-4	R80135	135-4	R84011	135-4
R4382-1	135-6	R8004	135-4	R80136	135-4	R84014	135-3
R4383-1	135-6	R8005	135-4	R80137	135-4	R84015	135-3
R4393-2	135-6	R8006	135-4	R80139	135-4	R84020	135-4
R4394-2	135-6	R8007	135-2	R80140	135-4	R84021	135-3
R4452-1	135-4	R8059	135-4	R80145	135-4	R84035	135-4
R4548	135-4	R8060	135-4	R80155	135-4	R84047	135-4
R4671	135-6	R8181	135-4	R80163	135-4	R89834	135-4
R4672	135-6						

Vacuum Secondary Operation

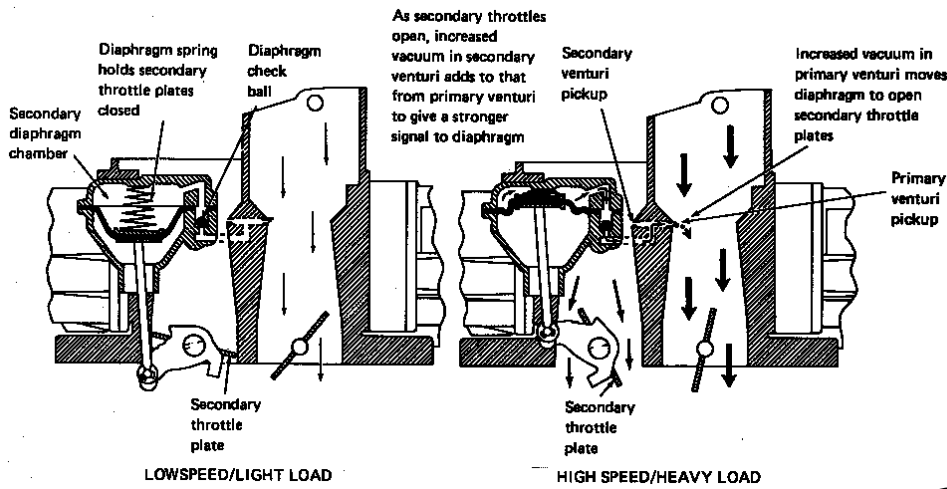

Tech Line: 270-781-9741

67

CARBURETORS
FUEL METERING
THROTTLE BODIES
FUEL PUMPS
INTAKE MANIFOLDS
SPRINGS
CYLINDER HEADS
SYSTEMS
WATER PUMPS
DRESS-UP
BATTERY
STREET & TRUCK AIDERS
POINT-OF-SALE
NEW/UPGRADES

Carburetors



Secondary Diaphragm Spring Kit

Part # **20-13^(B)**

Color	Relative Load	Secondary Throttle Operating Ranges			
		350 CID Eng. Opening RPM		402 CID Eng. Opening RPM	
		Initial	Full	Initial	Full
White	Lightest	—	—	—	—
Yellow*	Lighter	1620	5680	1410	4960
Yellow	Light	1635	5750	1420	5020
Purple	Med. Light	1915	6950	1680	6050
Plain	Medium	2240	8160	1960	7130
Brown	Med. Heavy	2710	8750	2380	7650
Black	Heavy	2720	Not Fully Open	2390	Not Fully Open

* Short Spring

Clamp Kit –

Choke Control Cable

Part #

45-456

For manual chokes. Required when changing over from plastic to metal diaphragm cover.

Cover –

Diaphragm Housing

Part #

20-28

2 x 4 bbl. applications. Allows vacuum hookup between carburetors for more even and balanced secondary operation.

Cover –

Diaphragm Housing

Part #

20-77

1 x 4 applications. Replacement plastic cover for 4 bbl. carburetor.

Cover –

Diaphragm Housing

Part #

Standard **20-85**

Shiny **20-85S**

1 x 4 applications. Replacement metal cover for 4 bbl. carburetor.

Secondary Diaphragm

Housing and Cover

Part #

34-503

Replacement chrome housing and cover for vacuum secondary carburetors.

NOTE: If carburetor is equipped with a black plastic cover then you must also purchase a special choke cable clamp kit, P/N 45-456, if you wish to retain hand choke cable operation.

Cover –

Diaphragm Housing – Adjustable

Part #

20-99^(B)

A must for bracket racers! This unique kit is designed to limit the opening of vacuum-actuated, secondary throttle plates. This is accomplished easily and accurately by turning a specially calibrated knob. Now you can have the ability to speed up or slow down your race car and thus compensate for changing track and atmospheric conditions. Keep running on your “dial-in” with this kit! Cannot be used with stock air cleaners.

Gasket (cork)

Part #

108-67-20

Seals vacuum passage between vacuum secondary housing and main body. Also is used with automatic choke housings.

Cover –

Diaphragm Housing (Quick Change)

Part #

20-59^(B)

1x 4 bbl. – without balance tube. Expedites changing of vacuum spring.

Cover –

Diaphragm Housing (Quick Change)

Part #

20-73^(B)

2 x 4 bbl. – with balance tube. Expedites changing of vacuum spring.



Venturii Booster Kits – DOMINATOR Carburetors

Part #



34-32



34-9

Short-style booster. Includes 4 boosters and 4 retaining pins.

34-32

Annular-style booster. Includes 4 boosters and retaining pins.

34-9

Annular/skirt-style booster for HP-style DOMINATOR.
Includes 4 boosters and 4 retaining pins.

34-36

Annular-style booster for HP-style DOMINATOR.
Includes 4 boosters and 4 retaining pins.

34-34



34-34



20-110-10

750 DOMINATOR Booster Kit

34-33

Booster Pins

Part #

Booster pins. 10/pkg.

20-110-10

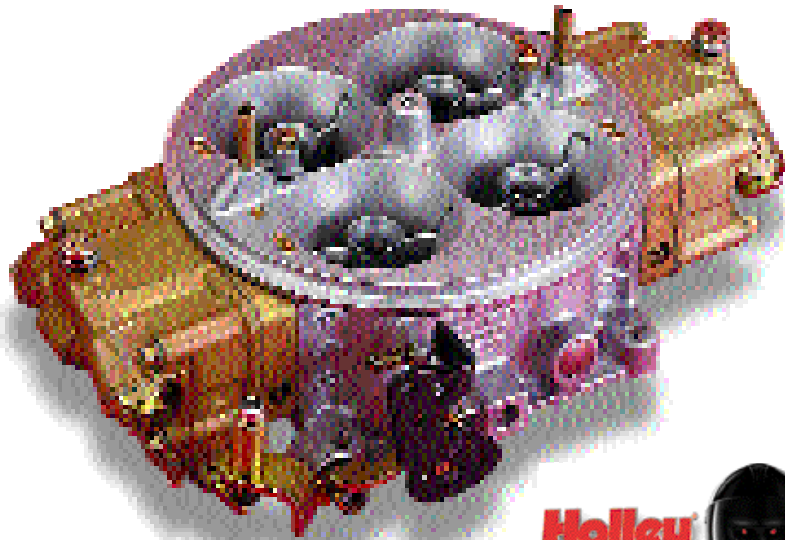

CARBURETORS

FUEL
METERING

THROTTLE
BODIES

FUEL PUMPS

INTAKE
MANIFOLDS

SPRINGS
AND
SHOCKS

CYLINDER
HEADS

SYSTEMS

WATER
PUMPS

DRESS-UP

BATTERY

STREET & TRUCK
ADAPTERS

POINT-OF-SALE

NEW/
VARIANTS

Tech Line: 270-781-9741

69

Carburetors

Adjust-A-Jets



55001



55008



55009

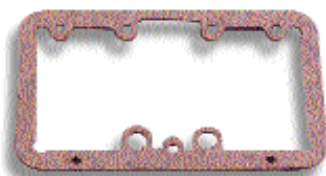

55010

These kits are designed to allow one to adjust the main jet metering of a carburetor without having to remove the fuel bowl(s) to access the main jets. The carburetor can now be calibrated on the motor saving time and avoiding fuel spills.

This is accomplished simply by turning the metering needle that is part of the Adjust-A-Jet metering plate. The metering plate is installed between the carburetor's fuel bowl and original metering block. The needle is completely adjustable and metering changes are easily accomplished once the embossed calibration markings on the needle are noted and referenced. Each of these markings designate 1/8th of a turn. By referring to a handy metering correlation chart included as part of the kit, one can accurately richen or lean the carburetor's main metering calibration. The carburetor can be tuned even when the engine is running. See the chart below for the range of adjustability that's possible with these kits.

Adjust-A-Jet can be used on any kind of vehicle. It does not affect the carburetor in any other way, so everything that you've ever learned about a Holley carburetor still applies. Adjust-A-Jet, CNC machined from 6061 T-6 aluminum, can even be used with a power valve plug installed in the carburetor's metering block.

Adjust-A-Jet Kits

Part

Holley carburetor models 2300, 4150 & 4160	55001HOL
DOMINATOR carburetors running gasoline (contains one (1) Adjust-A-Jet plate)	55002HOL
Holley model 4150 carburetor – primary side Circle track (gas)	55004HOL
4500 DOMINATOR HP	55011HOL

Adjust-A-Jet Kit Accessories

Part

Transfer tube – model 4160 carburetor (includes seal)	55008HOL
Main metering jet extensions (pair) (use of "notched" float is not required)	55009HOL
Replacement reusable gaskets (pair)	55010HOL

Correlation Chart – Jet Size to Metering Needle Adjustment (number of turns open)

60 = 1	70 = 2-1/8	78 = 3-5/8	86 = 5-5/8	94 = 9
62 = 1-1/8	71 = 2-1/4	79 = 3-3/4	87 = 5-3/4	95 = 9-1/2
64 = 1-1/4	72 = 2-3/8	80 = 4	88 = 6	96 = 10-1/2
65 = 1-1/2	73 = 2-1/2	81 = 4-1/2	89 = 6-1/2	97 = 11-1/2
66 = 1-5/8	74 = 2-5/8	82 = 4-3/4	90 = 7	98 = 12
67 = 1-3/4	75 = 2-3/4	83 = 5	91 = 7-1/2	99 = 13
68 = 1-7/8	76 = 3	84 = 5-1/4	92 = 8	
69 = 2	77 = 3-1/2	85 = 5-1/2	93 = 8-1/2	



Carburetor Throttle Linkage Service Parts

CRBURETORS
FUEL METERING
THROTTLE BODIES
FUEL PUMPS
INTAKE MANIFOLDS
SUPPCHARGERS
CYLINDER HEADS
SPARKS
WATER PUMPS
DRESS-UP
BATTERY
STREET & TRUCK ADAPTERS
POINT-OF-SALE
NEW/UPGRADES

NEW!



Secondary Adjusting Lever Kit

Part #
26-137

Allows quick and easy adjustment of secondary throttle blade idle setting of Holley 4150 series mechanical secondary carburetors without having to remove the carburetor from the intake manifold.

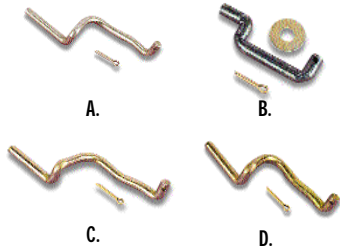

Secondary Connecting Rods

Part #

- A. Model 4160/4010 vacuum secondary connecting rod **20-53**
- B. Model 4150/4010 mechanical secondary connecting rod **20-54**
- C. Model 4175/4011 vacuum secondary connecting rod **20-55**
- D. Model 4150 vacuum secondary connecting rod **20-65**



Secondary Linkage

Part #

- E. 1:1 linkage ratio, model 4500 DOMINATOR **20-5**
- F. Progressive linkage, model 4500 DOMINATOR **20-6**
- G. "Soft" progressive linkage, model 4500 DOMINATOR **20-20**



Spark fitting

Part #

- H. Spark Fitting - Metering Block 180° style **26-59**



Throttle Lever & Cruise Control Studs

Part #

- I. Throttle and cruise control stud (GM) **20-36**
- J. Throttle stud; 7/32" dia. **20-37**
- K. Throttle stud; 1/4" dia. **20-38**
- L. Throttle stud; 1/4" dia. **20-39**
- M. Transmission kickdown stud **20-40**
- N. Throttle and cruise control stud **20-64**
- O. Throttle and cruise control stud (Chrysler) **20-67**
- P. Throttle ball assortment **20-2**



Throttle Cable Clip

Part #

- Q. Cable clip **26-104-10**



Throttle Lever Stud Bushing

Part #

- R. Stud bushing **26-103**

Tech Line: 270-781-9741

Carburetors

Carburetor Throttle Linkage Service Parts

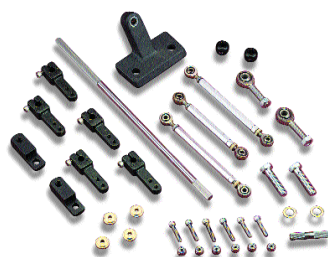

4021

Throttle Linkage Kits

- Chevy small block (2x4 tunnel ram/side-mounted carbs.)
- Chevy big block (2x4 tunnel ram/side-mounted 4150 carbs.)
- Chevy big block (2x4 tunnel ram/side-mounted DOMINATOR carbs.)
- Chrysler engines (2x4 tunnel ram/side-mounted carbs.)
- Ford 289/302 - 351C (2x4 tunnel ram/side-mounted carbs.)
- Ford 429 wedge - 460 (2x4 tunnel ram/side-mounted carbs.)
- Universal (2x4 tunnel ram/in-line-mounted carbs.)

Part #

- 4021**
- 4022**
- 4032**
- 4023**
- 4025**
- 4027**
- 4000**



26-93

26-94



26-128

Throttle Plate Kits

Each Kit contains four (4) plates and eight (8) screws.

- 1-7/16" plate diameter, .152" hole size
- 1-11/16" plate diameter, Ø hole size
- 1-11/16" plate diameter, .093" hole size
- 1-11/16" plate diameter, .150" hole size
- 1-3/4" plate diameter, Ø hole size
- 1-3/4" plate diameter, .100" hole size
- 1-3/4" plate diameter, .125" hole size
- 2" plate diameter, Ø hole size
- 2-1/8" plate diameter, Ø hole size

Part #

- 26-93**
- 26-94**
- 26-95**
- 26-96**
- 26-97**
- 26-98**
- 26-99**
- 26-100**
- 26-128**



20-3

Throttle Shaft Conversion Kits

1:1 linkage ratio, 1-11/16" throttle bore size

Part #

- 20-3**

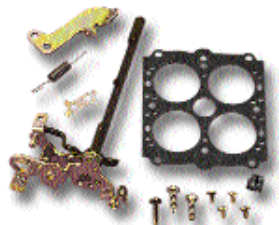

20-48-1

Throttle Shaft Service Kits

- With Ford A/T kickdown lever; R1850 carburetor
- With Ford A/T kickdown lever; R3310 carburetor
- With Ford A/T kickdown lever; R4412 carburetor
- 4500 DOMINATOR

Part #

- 20-48-1**
- 20-49-1**
- 20-62**
- 20-104**



Carburetor Throttle Service Parts

Part #

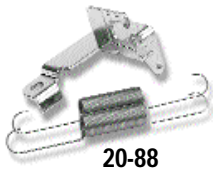

20-88

Throttle Cable Bracket

Chrome throttle cable bracket and throttle return spring installation. Includes dual stainless steel throttle return springs (P/N 20-89). Works on Holley models 4150 and 4160 carburetors.

20-88

Throttle Return Springs (2)

20-89



20-32

Throttle Cable Bracket(s)

These throttle cable brackets are designed to be used with Holley spread bore model 4165/4175 carburetors. They mount off the back carburetor mounting ear and accept the Chevrolet throttle cable.

20-32

20-44



46-74

Throttle Solenoid

Replacement for GM P/N 2060106. Can be used on many Holley aftermarket carburetors when used with the appropriate Holley solenoid bracket.

46-74



20-47

Throttle Solenoid Bracket

Can be used on many Holley aftermarket carburetors. Use with solenoid, P/N 46-74 and locknut, P/N 26-57.

20-9

Throttle Solenoid Bracket

Used on Holley model 4165/4175 carburetors. Used with solenoid P/N 46-74 and locknut P/N 26-57.

20-47



20-35

Transmission Kickdown Throttle Linkage

This part will bolt to the throttle lever of a Holley model 4165/4175 carburetor. It will provide an effective mounting point for the transmission kickdown carburetor hookup.

20-35



20-45

TH-350 Transmission Kickdown Cable Manifold Bracket

This bracket is designed to bolt on to a small block Chevrolet V8 intake manifold. It acts as a convenient mounting point for the TH-350 kickdown cable.

20-45



20-95

TH-700R4 Transmission Kickdown Cable Carburetor Bracket

This bracket is designed to be used only on Holley model 4150 or 4160 carburetors. It bolts on the carburetor flange ear and provides an effective mounting point for the AOD transmission cable and throttle cable.

20-95

This bracket is designed to be used only on the Holley model 4011 carburetor. It bolts on the carburetor flange ear and provides an effective mounting point for the AOD transmission cable and throttle cable.

20-100

CARBURETORS

FUEL METERS

THROTTLE BODIES

FUEL PUMPS

INTAKE MANIFOLDS

SUPERCARGERS

CYLINDER HEADS

SYSTEMS

WATER PUMPS

DRESS-UP

BATTERY

STREET & TRUCK ADAPTERS

POINT-OF-SALE

NEW/UPGRADES

Tech Line: 270-781-9741

73

Carburetors

Ford Brackets

Part #



Transmission Kickdown Lever Extension

This handy part is used to extend the Ford O.E. transmission kickdown lever when converting from a 2 bbl to a 4 bbl carburetor.

20-41



Transmission Kickdown Spring and Bracket

The bracket has one mounting hole and a locator pin. For carburetors with a 30cc accelerator pump.

20-60



Transmission Kickdown Spring and Bracket

Bracket has two mounting holes. For carburetors with a 30cc accelerator pump.

20-91

Chrysler Throttle Lever Extensions

Part #



Throttle Lever Extension

This part was originally released for use with Holley square flange carburetors, lists R7987 and R8006. It will relocate the throttle lever mounting point for the accelerator cable.

20-14



Throttle Lever Extension

This most popular Chrysler throttle lever extension will install on any Holley square flange carburetor with the universal throttle linkage. It readily accepts the Chrysler throttle lever stud for a simple and convenient throttle hookup.

20-7

Universal Brackets

Part #



Dashpot/Solenoid Bracket

This universal bracket is designed for use with all Holley carburetors that have the universal throttle lever and two threaded bracket mounting holes machined in the throttle body. Use dashpot P/N 11-4.

20-72



Dashpot/Solenoid Bracket

This universal bracket is designed for Holley model 4160 carburetors with universal throttle lever and two threaded bracket mounting holes machined in throttle body. Use dashpot P/N 11-4.

20-58



Dashpot/Solenoid Bracket

Universal bracket designed for Holley model 4160 carburetors with universal throttle lever. Bracket has one mounting hole and locating pin. Will fit on throttle body that has one machined bracket mounting hole and one "blank" hole. Use dashpot P/N 11-4.

20-17



Universal Brackets- (cont'd)



Throttle Cable Bracket - Billet Aluminum

Part #

20-112

The perfect finishing touch for street rods, street machines and street/strip cars and trucks. Why go cheap on a throttle return bracket when you can get a good looking, quality piece made of billet aluminum? Let's face it, the throttle cable/return spring bracket is one of the first things your eyes focus on when you lift the hood of any car. You can't help but miss it because it's right out there in the open!

If you're going the route, go the whole way with something that looks good while providing a real measure of safety. This red anodized bracket is multi-adjustable to work on Holley models 4150 and 4160 carburetors. It includes a dual return spring combination that's perched on a uniquely effective mount. Hardware is all stainless steel to stand up to the rigors of time. The Holley name is boldly engraved and provides a very special touch to this outstanding product.

Universal Dashpot

Part #



11-4

Universal dashpot is designed to be used on manual-transmission-equipped vehicles. Its purpose is to prevent engine stalling on sudden deceleration. This dashpot can be used with Holley brackets P/Ns 20-72, 20-58 and 20-17.

Universal Throttle Solenoid

Part #



46-74

This universal solenoid can be used with Holley bracket P/Ns 20-9 and 20-47.

Universal Solenoid and Dashpot Bracket Locknut

Part #



26-57

Hex Size: 1.25"
Thread Size: 7/8"-14

CARBURETORS
FUEL METERING
THROTTLE BODIES
FUEL PUMPS
INTAKE MANIFOLDS
SPRINGS/SHOCKS
CYLINDER HEADS
SPARK PLUGS
WATER PUMPS
DRESS-UP
BATTERY
STREET & TRUCK ADAPTERS
POINT-OF-SALE
NEW/ VARIANTS

Tech Line: 270-781-9741

75

Carburetors

CARBURETOR SMALL PART KITS

Part #

Hard-to-find parts are no longer "hard to find" with Holley parts kits. Available carburetor and electric fuel pump small parts kits now eliminate the problem of finding the correct components when rebuilding. The following kits are available:



Carburetor Small Parts Kit **34-10**

This kit consists of a selection of commonly used O-rings, E-rings, C-rings, check balls, washers, cotter pins and rod retainers.



Carburetor Small Gasket and Plug Kit **36-117**

This kit consists of various small gaskets, plugs and seals for transfer tubes, power valves, vacuum secondary housing, needle and seat hardware and pump discharge nozzles.



Carburetor Hardware Parts Kit **36-118**

This kit consists of carburetor hardware components such as throttle shaft bushings, idle needles, check balls, rods, retainers, screws and plugs.

DOMINATOR Carburetor Tuning Kits

4500 DOMINATOR Carburetors **36-200^(B)**

4500 DOMINATOR HP Carburetors **36-244^(B)**

These kits contain an assortment of special tuning parts for either the old-style DOMINATOR or new-design DOMINATOR HP carburetors. Included are 1 EA. secondary linkage cams to allow conversion to 1:1, progressive or "soft" progressive ratios; 4 EA. standard and annular booster venturii (36-200 kit); 4 EA. standard and skirted annular booster venturi (36-244 kit); 2 EA. white and yellow pump cams; 12 EA. throttle plate screws; 8 EA. metering block and fuel bowl gaskets. These are all included in a handy and very durable plastic carrying case.

(B) Not legal for sale or use in California on any pollution controlled motor vehicles.



36-200



CARBURETOR SMALL PART KITS

Part #



Tuning/Calibration Kit Double pump carburetors

36-182^(B)

This tuning kit contains a selection of main jets, pump nozzles and power valves, in popular sizes, all contained in a handy and durable, compartmentalized plastic case. Ideal for track-side tuning, this kit provides a quick and easy way to accomplish your carburetor tuning with the correct parts. In addition, the parts case allows you to keep parts organized and readily at hand. A handy parts guide is affixed to the inside case cover. Numbers referenced on the parts guide will assist in reordering components when necessary. Gaskets are included to facilitate carburetor reassembly.

THE FOLLOWING PARTS ARE INCLUDED:

QUANTITY	DESCRIPTION
4 each of	Eight (8) metering jet sizes ranging from #70 to #84
2	#35 Pump Nozzle
2	#37 Pump Nozzle
1	#35 Power Valve
1	#45 Power Valve
1	#50 Power Valve
12	Metering Block Gaskets
12	Fuel Bowl Gaskets
—	Miscellaneous pump nozzle, power valve and fuel bowl screw gaskets



Accelerator Pump Tuning Kit Holley 2-bbl and 4-bbl Performance Carburetors

36-184^(B)

This tuning kit is composed of a selection of accelerator pump hardware components including pump diaphragms, pump nozzles, pump cams and related parts. Contained in a convenient plastic parts case, this kit has all that is required to properly tune and calibrate the accelerator pump circuit(s) for your street, drag or circle track car or tow vehicle. A handy parts guide is affixed to the inside case cover to assist in reordering components when necessary.

THE FOLLOWING PARTS ARE INCLUDED:

QUANTITY	DESCRIPTION
2 each of	Twelve (12) pump discharge nozzle sizes ranging from .025 to .052
2 each of	Ten (10) accelerator pump cam profiles (colors)
5	50cc GFLT pump diaphragm
5	30cc GFLT pump diaphragm
—	Miscellaneous screws, gaskets, check valves and weights



Vacuum Cap Assortment

26-105

A selection of different size vacuum tube caps.
An indispensable addition to any professional tool kit.

(B) Not legal for sale or use in California on any pollution controlled motor vehicles.

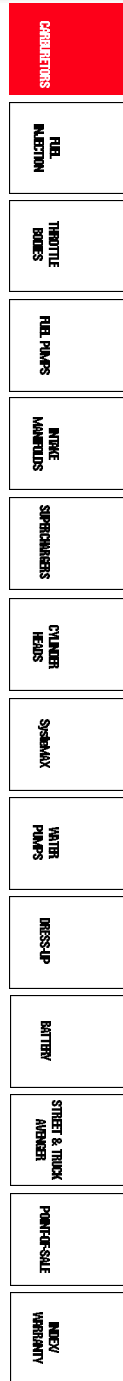

Tech Line: 270-781-9741



Carburetors

Choke Control Cable (Manual)

Part #



The perfect item to complete your purchase of the Holley manual choke conversion kit. Can also be used on all Holley manual choke carburetors (like the double pumpers) or any other manual choke carburetor. Cable length is 6 feet and the control knob has the Holley name prominently displayed.

45-228

Choke Control Cable (Manual) Mounting Hardware

Part #



45-229

Universal bracket mounts inside vehicle, under dashboard, to secure control cable.

45-229



45-456

Manual choke cable clamp kit for use only on Holley carburetor models 4010, 4150 and 4160. Mounts on vacuum secondary housing cover.

45-456

Choke Conversion Kits (Electric & Hot Air)

Part #



45-224

These kits can be used to convert Holley carburetors which originally came equipped either with a hot air or manually-operated choke to full automatic/electric operation.

Carburetors designed with an "internal vacuum source" such as 0-1850, 0-3310, 0-6425 or 0-7448.

Standard finish **45-223**
Shiny finish **45-223S**

Carburetors designed with an "external vacuum source" such as 0-4412, 0-4776, 0-4777, 0-4778, 0-4779, 0-4780, 0-4781, 0-6299, 0-6708 and 0-6709.

Standard finish **45-224**
Shiny finish **45-224S**

Carburetors designed originally with a integral hot air choke.

45-226

Choke Conversion Kit (Manual)

Part #



45-225

All the parts required for a fast, easy changeover to hand choke operation. For all carburetor models 2300, 4150 and 4160 carburetors with choke hardware mounting bosses on side of main body.

Standard finish **45-225**
Shiny finish **45-225S**



Choke Thermostat Cap Retainer Kits



Used on Holley carburetor models 2300, 4150 and 4160.

Part #
Standard finish **45-377**
Shiny finish **45-377S**

Electro-Dyn Heat Sensor



This sensor allows the choke to automatically speed up or slow down its operation by sensing intake manifold and engine block heat.

Part #
45-267

Fast Idle Cam



Used on Holley carburetor models 4150 and 4160.

Part #
45-376

Fast Idle Cam Plate - Chrome

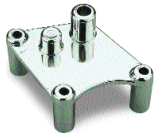

Used on Holley carburetor models 4010, 4011, 4150 and 4160.

Part #
34-506

Miscellaneous Choke Parts

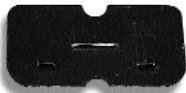

45-458



45-520

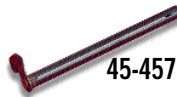

45-457

Used on Holley carburetor models 4150 and 4160.

Choke rod **45-520**
Choke plate **45-458**
Choke shaft - metal **45-457**

Replacement Electric Choke Caps



45-258

Carburetor models 4165, 4175 and 4360

Part #
45-230

Carburetor models 2300, 4150, 4160, 4010 and 4011.
Also for Holley choke conversion kits P/Ns 45-223, 45-224, 45-226, 45-449, 45-450 and 45-459.

45-258

- CARBURETORS
- FUEL INJECTION
- THROTTLE BODIES
- FUEL PUMPS
- INTAKE MANIFOLDS
- SPRINGS/SHOCKS
- CYLINDER HEADS
- SYSTEMS
- WATER PUMPS
- DRESS-UP
- BATTERY
- STREET & TRUCK ADAPTERS
- POINTS/SHOCKS
- MISC/ VARIANTS

Tech Line: 270-781-9741

Carburetors



34-2



134-101



134-102S



134-110

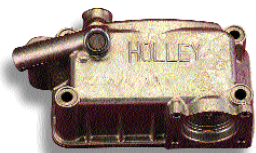

34R-7960A

Fuel Bowl Conversion Kit

Part # **34-2**

Fits model 4150/4160 single pump carburetors. Converts a carburetor equipped with single inlet, side-hung style fuel bowls, with transfer tube, to dual inlet center-hung fuel bowls. Dual inlet bowls can be plumbed from either side.

Replacement Fuel Bowl Kits

Part #

Replacement primary fuel bowl. Side-hung-float style with provision for transfer tube and accelerator pump. Used on model 4160 carburetors.

Standard

134-101

Shiny

134-101S

Replacement secondary fuel bowl. Side-hung-float style with transfer tube provision only.

Standard

134-105

Shiny

134-105S

Replacement primary fuel bowl. Center-hung-float style with provision for accelerator pump and fuel inlet. Used on 3310 and double pump carburetors.

Standard

134-103

Classic

134-103C

Shiny

134-103S

Replacement secondary fuel bowl. Center-hung-float style with provision for accelerator pump and fuel inlet. Used on double pump carburetors.

Standard

134-104

Classic

134-104C

Shiny

134-104S

Replacement secondary fuel bowl. Center-hung-float style with fuel inlet provision only.

Standard

134-102

Shiny

134-102S

Replacement primary fuel bowl. Center-hung-float style with provision for dual fuel inlets. Used on DOMINATOR carburetors.

Standard

134-108

Replacement secondary fuel bowl. Center-hung-float style with provision for accelerator pump and dual fuel inlets. Used on DOMINATOR carburetors.

Standard

134-112

Replacement primary fuel bowl. Side-hung-float style with provision for side fuel inlet off the front face of the bowl. Does not have vent provision. Used on models 4165 and 4175 spread bore carburetors.

Standard

134-110

Shiny

34R6662-3AMP

Replacement secondary fuel bowl. Models 4165 and 4175 carburetors.

Standard

34R7960A

Shiny

34R7960-3AMP



Fuel Bowl — Quick Change Jet Kits



34-509



34-27



26-68



26-85

Cool your jets! Getting hot under the collar when jet-changing can now be a thing of the past. Holley makes it easy with a "quick change jet kit". Designed for the center-hung-style "race" fuel bowl, the kit will allow you to change jets without having to remove the fuel bowl. Simply unscrew the jet "plugs" which thread into the bowl and use the Holley jet tool to remove the old jet. Screw in the new jets, replace the plugs, and you're ready to ride.

Holley quick change jet kits come complete, ready for installation. They include the quick change fuel bowls, gaskets, washers, seals, fuel bowl plugs and jet tool. Everything that you need for an easy conversion. "Quick Change". A new standard of convenience from Holley.

Features

- Allows jet changes without removing the fuel bowl
- For carburetors with center hung fuel bowls
- Complete kits including:
 - Fuel Bowl
 - Gaskets
 - Plugs
 - Jet removal tool included with primary bowls
- Available in standard and chrome finishes
- Provides quick and easy jet changes
- Unique removal tool firmly holds jet

Kit Description

Model 4500 DOMINATOR carburetors. Primary and secondary dual inlet fuel bowls.

Model 4150/4160 carburetors. Primary fuel bowl with single fuel inlet

Model 4150 carburetors. Secondary fuel bowl with single fuel inlet and accelerator pump

Model 4150 carburetors. Secondary fuel bowl with single inlet and no accelerator pump

Service Parts

Replacement jet removal tool

Fuel bowl plug gasket (10)

Fuel bowl plug (2)

Part

Standard **34-24**
 Chrome **34-508**

Standard **34-25**
 Chrome **34-509**

Standard **34-26**
 Chrome **34-510**

Standard **34-27**
 Chrome **34-511**

Part

26-68

108-77

26-85

CARBURETORS

FUEL
METERING

THROTTLE
BODIES

FUEL PUMPS

INTAKE
MANIFOLDS

SUPERSCHUBERS

CYLINDER
HEADS

SPARK
PLUGS

WATER
PUMPS

DRESS-UP

BATTERY

STREET & TRUCK
AERIALS

POINT-OF-SALE

INDEX/
VARIANTS

Tech Line: 270-781-9741

81

Carburetors



Fuel Bowl Kits

	Part #
Side hung float design, single pump, single inlet with transfer tube provision.	34-500
Center hung float design, single pump.	34-501
Center hung float design, double pump. Will not work on lists 0-6708, 0-6709, 0-7010	34-502

Fuel Bowl Sight Plug Window Kits

Holley's fuel bowl sight plug window kits will enable you to eyeball carburetor's fuel level without ever having to remove another sight plug. No muss, no fuss, no mess. Fuel bowls come polished.	
Single inlet fuel bowl. Contains primary and secondary bowls.	34-37
Dual inlet fuel bowl. Contains primary and secondary bowls.	34-38
Sight window service part	26-112

Fuel Bowl Screw Drain Kit

26-133 	Holley 2-bbl and 4-bbl carburetors • Allows safe, easy on-car drainage of the fuel bowl	26-133
--	--	---------------

Fuel Bowl Screw Gasket Kits

108-98-10 	Standard replacement paper gasket Reusable nylon gasket.	108-2-20 108-98-10
---	---	-------------------------------------

Fuel Bowl Sight Plug and Gasket Kits

26-13 	Standard replacement Replacement see-thru sight plug with O-ring seal	26-13 26-113
--	--	-------------------------------



Fuel Bowl Vent Screen

26-39 	Helps to prevent fuel from spilling out of the fuel bowl vent tubes.	26-39
---	--	--------------



Fuel Bowl Vent Baffle/Whistle

26-40 	Designed to be used only with the center-hung style float bowl. 2" length They act to prevent fuel from splashing out the vent tube. 1-7/16" length	26-40 26-89
---	--	------------------------------

Fuel Transfer Tubes

	Carburetor models 4150 and 4175	26-114
	Carburetor model 4160	26-115
	Carburetor model 4165	26-116

Fuel Transfer Tube Seals

108-97 	Works on old-style transfer tubes 2/pkg.	26-37
26-37 	Replacement Viton seal for new-style transfer tube	108-97

Fuel Bowl Vent Tubes

26-107-10 	Replacement vent tube with angle cut	26-107-10
---	--------------------------------------	------------------



26-73

26-75



26-77



26-76

26-18-2



26-26



26-43

26-29



26-69



26-70



26-102

Fuel Inlet Fitting

For Center Hung Fuel Bowl

SIZE	Description
7/8-20 to -6AN	aluminum red anodized
7/8-20 to -6AN	steel

Part #

26-73

26-74

For Side Hung Fuel Bowl

9/16-24 to -6AN	aluminum red anodized
-----------------	-----------------------

26-75

Adapter Fitting

Holley Adapter Fittings are used to help plumb your carburetor from your fuel pump, regulator, or fuel log.

SIZE
3/8NPT to -6AN Straight

Part #

26-77

Fuel Inlet Plug

Aluminized red anodized
Steel

SIZE
7/8-20
7/8-20

Part #

26-76

26-18-2

Inverted Flare Fittings

Inverted Flare Fitting, Tube: 3/8", Thread: 7/8-20 (A) x 5/8-18 (B)
Inverted Flare Fitting, Tube: 5/16", Thread: 7/8-20 (A) x 1/2-20 (B)
Inverted Flare Fitting, Tube: 5/16", Thread: 9/16-24 (A) x 1/2-20 (B)
Inverted Flare Fitting, Tube: 5/16", Thread: 7/16-20 (A) x 1/2-20 (B)
Inverted Flare Fitting, Tube: 1/4", Thread: 7/8-20 (A) x 7/16-24 (B)

Part #

26-26

26-27

26-71

26-86

26-28

Standard Fittings

Standard Fitting, Tube: 3/8", Thread: 9/16-24 (A) x 5/8-18 (B)
Standard Fitting, Hose: 3/8", Thread: 9/16-24 (A)
Standard Fitting, Hose: 5/16", Thread: 9/16-24 (A)
Swivel Fitting, Hose: 5/16", Thread: 9/16-24
Standard Fitting (90°), Hose: 5/16", Thread: 1/2-20

Part #

26-43

26-29

26-24

26-25

26-44

Fittings for Fuel Pressure Gauges

Fuel Pressure Gauge Fitting, 90° male elbow

Part #

26-69

Fuel Line Fitting

Fuel Line Adapter, Connect a 3/8" fuel line to a 5/16" fuel line

Part #

26-70

Fitting Gaskets

Fuel Bowl Inlet Fitting Gasket, Size: 9/16"
Fuel Bowl Inlet Fitting Gasket, Size: 7/8"
Fuel Bowl Inlet Fitting Gasket, Size: 7/8" - Nylon

Part #

108-1

108-8

26-102

CARBURETORS

FUEL
METERING

THROTTLE
BODIES

FUEL PUMPS

INTAKE
MANIFOLDS

SUPPLEMENTARY

CYLINDER
HEADS

SYSTEMS

WATER
PUMPS

DRESS-UP

BATTERY

STREET & TRUCK
ADAPTERS

POINT-OF-SALE

INDEX/
VARIANTS

Tech Line: 270-781-9741



83

Carburetors

FUEL LINE SELECTION CHART

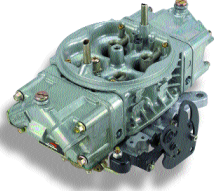

Ch

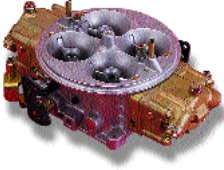
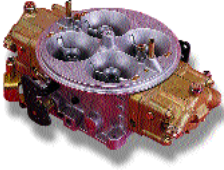
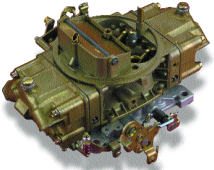
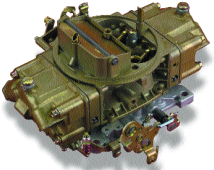
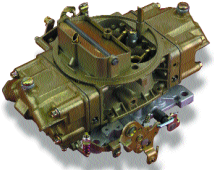
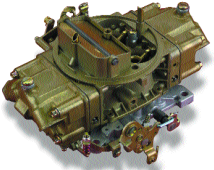
Application	Carburetor numbers	Description
 <p>4150/4150HP Models with 7/8-20 threads Center to Center = 9.25"</p>	Fits popular list numbers such as 0-4776, 0-4777, 0-4778, 0-4779, 0-80575, 0-80529-1 and the Street Avenger series etc.	-8AN O-ring port inlet. Tapped for 1/8" NPT pressure gauge 3/8" NPT female inlet. Tapped for 1/8" NPT pressure gauge -6AN male inlet -6AN Male on both ends -8AN Male Inlet -8AN Male on both ends
 <p>4150/4150HP Models with 5/8-18 inverted flare fuel fittings Center to Center = 9.25"</p>	Fits popular list numbers such as 0-4776, 0-4777, 0-4778, 0-4779, 0-80575, 0-80529-1 and the Street Avenger series etc.	5/8-18 NPT female inlet. Tapped for 1/8" NPT pressure gauge
 <p>4160 Models with 5/8-18 inverted flare fuel fittings Center to Center = 8.80"</p>	Fits Popular list numbers such as 0-3310, 0-80508, etc	5/8-18 NPT female inlet. Tapped for 1/8" NPT pressure gauge
 <p>4500 Model Dominators with 7/8-20 threads Center to Center = 11.25"</p>	Fits popular list numbers such as 0-8082-1, 0-8896-1, 0-80586, 0-9375-1, 0-9377-1 etc.	-8AN O-ring port inlet. Tapped for 1/8" NPT pressure gauge 3/8" NPT female inlet. Tapped for 1/8" NPT pressure gauge -6AN male inlet -6AN Male on both ends -8AN Male Inlet -8AN Male on both ends
 <p>4500 Models with 5/8-18 inverted flare fuel fittings Center to Center = 11.25"</p>	Fits popular list numbers such as 0-8082-1, 0-8896-1, 0-80586, 0-9375-1, 0-9377-1 etc.	5/8-18 NPT female inlet. Tapped for 1/8" NPT pressure gauge
 <p>Universal Fits 4160, 4150, and 4500 models with dual inlet bowls and 7/8-20 Threads</p>		3/8" NPT female inlet. Tapped for 1/8" NPT pressure gauge
 <p>Universal Fits 4150, 4500 models with 7/8 -20 threads</p>		-8 male inlet. 3/8" NPT outlet at rear of log.
 <p>Universal Fits 4160, 4150, and 4500 models with 5/8-18 Threads</p>		1/4" NPT female inlet. Tapped for 1/8" NPT pressure gauge
 <p>Universal Fits 4010, 4011 models</p>		1/4" NPT female inlet. Tapped for 1/8" NPT pressure gauge



Chrome	Bent Tube	Swivel Seal™	B-Nut Disassembly Swivel Seal™	Billet
-	103175ERL	-	-	-
-	103176ERL	-	-	-
-	-	101175ERL	101185ERL	-
-	-	101176ERL	101186ERL	-
-	-	101275ERL	101285ERL	-
-	-	101276ERL	101286ERL	-
34-150	-	-	-	-
34-160	-	-	-	-
-	104175ERL	-	-	-
-	104176ERL	-	-	-
-	-	102175ERL	102185ERL	-
-	-	102176ERL	102186ERL	-
-	-	102275ERL	102285ERL	-
-	-	102276ERL	102286ERL	-
34-550	-	-	-	-
-	105175ERL	-	-	-
-	-	-	-	34-39
34-1	-	-	-	-
34-16	-	-	-	-

CHROME FUEL LINES FOR HOLLEY 2010 & 2300



34-21

Universal 180°. Features 3/8" hose end and 5/8-18 inverted flare fitting



34-22

Universal 90°. Features 3/8" hose end and 5/8-18 inverted flare fitting

- CHROMIUMS
- FUEL INJECTION
- THROTTLE BODIES
- FUEL PUMPS
- INTAKE MANIFOLDS
- SUPPLEMENTALS
- CYLINDER HEADS
- SYSTEMS
- WATER PUMPS
- DRESS-UP
- BATTERY
- STREET & TRUCK ADAPTERS
- POINT-OF-SALE
- HAZARD/ALTERNATIVE

Tech Line: 270-781-9741

Carburetors

VoluMAX® Fuel Filters

Part #



162-515

Single inlet/outlet (-8 AN O-ring fittings)

162-514

Dual inlet/outlet (-8 AN O-ring fittings)

162-515

VoluMAX fuel filters have a very high flow capacity and feature a washable stainless steel, 60- micron filter element. The two-piece black anodized billet aluminum housing is CNC machined and can be rotated 360° to accommodate any required port alignment. A 3/8" mounting stud with lock washer and nut is provided to mount on your bracket.

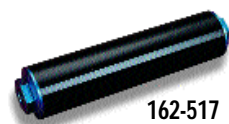

162-517

This filter features a tube-style design. It holds a very fine 7 micron paper element that's capable of filtering up to 750 gallons of fuel an hour. The filter is constructed of .150" wall aluminum tubing with an outer diameter of 2.5" and a length of 10". Removable end caps have AN pipe threads and are sealed with an O-ring. The caps have female 1/2" pipe threads so any fitting can be installed. The filter is anodized for appearance and protection against corrosion.

162-517



162-516



162-518

Replacement filter element for VoluMAX fuel filter. The fine 60 micron stainless steel screen is washable. One per package.

162-516

Replacement paper filter element for 162-517 fuel filter.

162-518

Fuel Filters & Elements

Part #



162-504

Universal Replacement Element (canister-type)

This universal fuel filter element is designed to fit many of the high capacity performance canister-type filters. Includes sealing gasket.

162-504



162-500

Carburetor Fuel Inlet Brass Filter

Moraine fuel inlet filter is brass and fits Holley 4-bbl carburetors with center-hung-style float bowls. Also is a stock replacement for Rochester Quadra-Jet carburetors. 2 per package.

162-500

In-Line Filters



162-523



162-506

HOSE SIZE	FINISH
3/8"	Clear/See-thru
3/8"	Chrome
5/16"	Chrome

162-506

162-523

162-524



VoluMAX® Filters and Components



10-6002SV



10-6028S

The Holley line of VoluMAX filters has been greatly expanded. It encompasses filter diameter sizes from 4" to 12" with single and dual inlet/outlets available. VoluMAX filters have a very high flow capacity and feature a washable, stainless steel filter screen that's available in 28, 60 and 115 micron ratings, depending on diameter.

The two-piece anodized billet aluminum housing is CNC-machined and can be rotated 360° to accommodate any required port alignment. A 3/8" mounting stud with lock washer and nut is provided to mount the filter on your bracket. VoluMAX filters can be used with gasoline, diesel fuel, oil or any fluid where the best filtration possible is required. For the ultimate filtration system, try Holley VoluMAX filters.

DESCRIPTION	PART #
4" filter w/ 60 micron screen, AN -8 O-ring and 3/8 NPTports	10-4001
4" filter w/ 60 micron/Viton screen, AN -8 O-ring and 3/8 NPTports	10-4001V
4" filter w/ 115 micron screen, AN -8 O-ring and 3/8 NPTports	10-4002
4" filter w/ 115 micron/Viton screen, AN -8 O-ring and 3/8 NPTports	10-4002V
4" filter w/ 28 micron screen, AN -8 O-ring and 3/8 NPTports	10-4028
4" filter w/ 28 micron Viton screen, AN -8 O-ring and 3/8 NPTports	10-4028V
4" 28 micron replacement screen	10-4000
4" 28 micron/Viton replacement screen	10-4000V
4" 60 micron replacement screen	10-4010
4" 60 micron/Viton replacement screen	10-4010V
4" 115 micron replacement screen	10-4020
4" 115 micron/Viton replacement screen	10-4020V
4" filter housing - service replacement	10-4999
6" filter w/ 60 micron screen, AN -12 O-ring and 3/4 NPTports	10-6001D
6" filter w/ 60 micron/Viton screen, AN -12 O-ring and 3/4 NPTports	10-6001DV
6" filter w/ 60 micron screen, single 3/4 NPTport	10-6001S
6" filter w/ 60 micron/Viton screen, single 3/4 NPTport	10-6001SV
6" weld-on w/ 60 micron screen, single 3/4 NPTport	10-6001WS
6" filter w/ 115 micron screen, AN -12 O-ring and 3/4 NPTports	10-6002D
6" filter w/ 115 micron/Viton screen, AN -12 O-ring and 3/4 NPTports	10-6002DV
6" filter w/ 115 micron screen, single 3/4 NPTport	10-6002S
6" filter w/ 115 micron/Viton screen, single 3/4 NPTport	10-6002SV
6" filter w/ 28 micron screen, AN -12 O-ring and 3/4 NPTports	10-6028D
6" filter w/ 28 micron/Viton screen, AN -12 O-ring and 3/4 NPTports	10-6028DV
6" filter w/ 28 micron screen, single 3/4 NPTport	10-6028S
6" filter w/ 28 micron/Viton screen, single 3/4 NPTport	10-6028SV
6" 28 micron replacement screen	10-6000
6" 28 micron/Viton replacement screen	10-6000V
6" 60 micron replacement screen	10-6010
6" 60 micron/Viton replacement screen	10-6010V
6" 60 micron multi-screen kit	10-6030S
6" 115 micron replacement screen	10-6020
6" 115 micron/Viton replacement screen	10-6020V
6" filter housing, service replacement, dual ports	10-6999D
6" filter housing, service replacement, single port	10-6999S
9" filter w/ 28 micron/Viton screen, AN -18 and 7/8 NPTports	10-9028DANPV
9" filter w/ 28 micron/Viton screen, dual AN -18 ports	10-9028DANV
9" filter w/ 28 micron/Viton screen, single AN -18 port	10-9028SANV
9" filter w/ 28 micron/Viton screen, single 7/8 NPTport	10-9028SV
9" 28 micron/Viton replacement screen	10-9000V
9" filter w/ 60 micron/Viton screen, AN -18 and 7/8 NPTports	10-9060DANPV
9" filter w/ 60 micron/Viton screen, dual AN -18 ports	10-9060DANV
9" filter w/ 60 micron/Viton screen, single AN -18 port	10-9060SANV
9" filter w/ 60 micron/Viton screen, single 7/8 NPTport	10-9060SV
9" 60 micron/Viton replacement screen	10-9010V
12" filter w/ 28 micron/Viton screen, single 1-1/4 NPTport	10-12028SV
12" filter w/ 28 micron/Viton screen, single AN -24 port	10-12028SANV
12" 28 micron/Viton replacement screen	10-12000V
12" filter w/ 60 micron/Viton screen, single 1-1/4 NPTport	10-12060SV
12" filter w/ 60 micron/Viton screen, single AN -24 NPTport	10-12060SANV
12" filter w/ 60 micron/Viton screen, dual AN -24 O-ring ports	10-12060DANV
12" 60 micron/Viton replacement screen	10-12010V

CRACKLEBOXES
FUEL METERS
THROTTLE BODIES
FUEL PUMPS
INTAKE MANIFOLDS
SUPERCHARGERS
CYLINDER HEADS
SYSTEMS
WATER PUMPS
DRESS-UP
BATTERY
STREET & TRUCK AERIALS
PUMP-UP-SALE
HAZARD

Tech Line: 270-781-9741

Carburetors

ADAPTERS

Part#

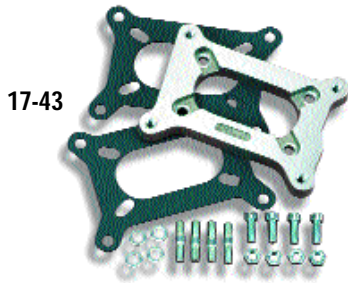

17-43

2300 flange to large Rochester 2GC

17-43

Cast aluminum
Open

2300 flange to square bore flange

7467

Cast aluminum
This adapter has slotted holes to permit "fine tuning" carburetor position on manifold. This adapter necks down from 1-3/4" to 1-1/4" to facilitate use in certain "restrictor class" circle track competition. Adapter can be bored out to match carburetor throttle bore for other applications.



7467

Spread bore to square bore

7461

Cast aluminum
5/8" thick (see picture on page 91)
This adapter will allow any spread bore carburetor to be mounted on manifolds designed originally for 4150 or 4160 carburetors. **WARNING:** Do not use on manifold with "angle-mounted" carburetor.

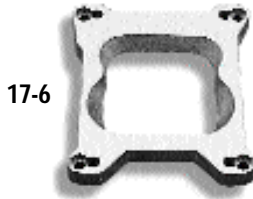

17-6

Square flange to spread bore

17-6

Cast aluminum
This adapter will allow any 4150 or 4160 carburetor to be mounted on manifolds designed originally for Rochester Quadra-Jet or Carter Thermo-Quad carburetors. It can also be used in reverse.



7539

Square flange to DOMINATOR

7539

Cast aluminum
2" height
This adapter will allow any 4150 or 4160 carburetor to be mounted on a manifold designed originally for a DOMINATOR carburetor.

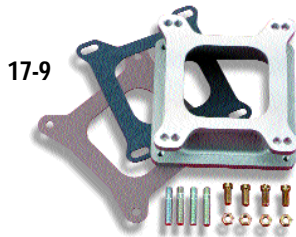

17-9

DOMINATOR to square bore

17-9

Cast aluminum
2-1/4" height
2" height

7466

These adapters allow a DOMINATOR carburetor to be mounted on a manifold designed originally for a 4150 or 4160 carburetor.



SPACERS

Part#



108-37

Spread Bore
Phenolic
5/8" height

108-37



17-63

2300 flange
Phenolic
1-11/16" bores
1" height

17-72



17-66

4150 flange
Phenolic
1-9/16" bores
1/2" height
1" height

17-59

17-63

Phenolic
1-11/16" bores
1" height

17-64

Aluminum
1-11/16" bores
1" height

17-75

Phenolic
1-3/4" bores
1" height

17-65

Phenolic
Open
1/2" height

17-62

1" height

17-66

Aluminum
Open
1" height

17-76



17-76

CHECKLIST
FUEL METERING
THROTTLE BODIES
FUEL PUMPS
INTAKE MANIFOLDS
SUPERCHARGERS
CYLINDER HEADS
SYMBAK
WATER PUMPS
DRESS-UP
BATTERY
STREET & TRUCK AIRBEN
POINT-OF-SALE
MONEY/ VARIANTS

Tech Line: 270-781-9741

Carburetors

SPACERS - (cont'd)

Part#

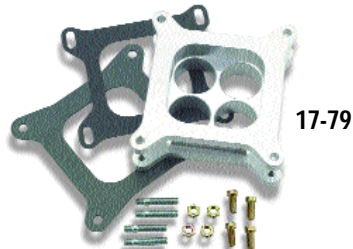

4150 flange

Billet aluminum
Open
Red anodized w/ 1/4" female NPT tap
1" height

717-10



Aluminum
4-hole/ Open combination
2" height

17-79

4150/AFB flange

Cast aluminum

Open
1" height

17-27



4-hole
1" height

17-34

1" height

7465

DOMINATOR flange

Phenolic
4-hole
1/2" height

17-67

1" height

17-68

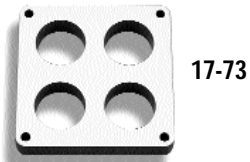

Billet aluminum
4-hole
1" height

17-73

Cast aluminum shear plate
w/ 7° tapered bore

17-57



Phenolic
Open
1" height

17-70



PLENUM DIVIDER KITS



Spread bore flange

Cast aluminum
5/8" height
Allows the use of a plenum divider on an open plenum manifold. Supplied with divider plate. **WARNING:** Do not use on manifold with "angle-mounted" carburetor.

Square bore flange

Cast aluminum
5/8" height
Allows the use of a plenum divider on an open plenum manifold. **WARNING:** Do not use on manifold with "angle-mounted" carburetor.

Part#

7461

7460

CARBURETORS

FUEL
MIXTURE

THROTTLE
BODIES

FUEL PUMPS

INTAKE
MANIFOLDS

SUPPLEMENTARY

CYLINDER
HEADS

SYMBAK

WATER
PUMPS

DRESS-UP

BATTERY

STREET & TRUCK
ADAPTERS

POINT-OF-SALE

INDEX/
VARIANTS

SEALING PLATE



Square bore to spread bore flange

1/16" height
Allows a square bore carburetor to mount directly to a spread bore manifold with dual bolt pattern and seal properly.

Part #

9006

TOOLS

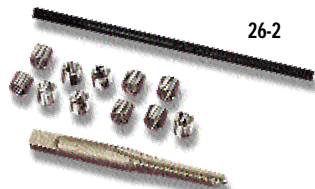

26-2

Heli-Coil Inserts

Use to repair stripped fuel bowl screw threads in a carburetor main body.

Installation Tool Kit

Main Jet Removal Tool

Used for jet removal.

Main Jet Tap

Used for "cleaning up" main jet threads in the metering block.

Rich/Lean Indicator with Oxygen Sensor

For carbureted, non-oxygen-sensor-equipped vehicles. Mounts on the dash and allows the monitoring of the air/fuel ratio of your engine while you drive. Enables more exact tuning.

Rich/Lean Indicator w/o Oxygen Sensor

For fuel injected vehicles or those that already are equipped with an oxygen sensor. Enables more exact tuning.

Part #

26-3

26-2

26-68

26-1

534-51

534-50



26-68

26-1



534-51

Tech Line: 270-781-9741

91

Carburetors

Gauges

Part #



26-503

Electric Fuel Pressure Gauge

Features

- Allows you to monitor fuel pressure while driving
- Dash mounting
- Includes sending unit
- Eliminates guesswork helps pinpoint fuel delivery problems
- Easily plumbs near carburetor fuel inlet

Electric Fuel Pressure Gauge Kit 0-15 psi
90° elbow to attach to Holley fuel lines

26-503
26-69



26-504

Mechanical Fuel Pressure Gauge

Holley offers two (2) types of mechanical fuel pressure gauges: dry and liquid filled. The "dry" gauges are offered in 0-15 and 0-30 PSI increments and are budget priced but not short on quality. The "liquid filled" gauges are also offered in the 0-15 and 0-30 PSI ranges. They contain a liquid glycerin which dampens the needle movement and makes it more linear in operation. Liquid gauges are premium quality instruments which will give years of service.

Features

- 1 1/2" Diameter
- Chromed steel case
- 1/8" NPT brass fitting
- Includes elbow fitting
- Fits Holley chromed fuel lines and fuel block

0-15 psi gauge (non-liquid filled)
0-30 psi gauge (non-liquid filled)
0-15 psi gauge (liquid filled)
0-30 psi gauge (liquid filled)
90° elbow to attach to Holley fuel line

26-500
26-502
26-504
26-505
26-69



90520

Vacuum Boost Gauge

Reads 0-30 inches of vacuum and 0-15 lbs. of boost.
Fits standard 2-1/16" diameter gauge hole.
Mounting hardware is included.

90520



26-501

Vacuum Gauge

Features

- 2" Diameter
- 0-30 in. HG
- Chromed steel case
- 1/8" NPT brass fitting
- Hose fitting included

26-501

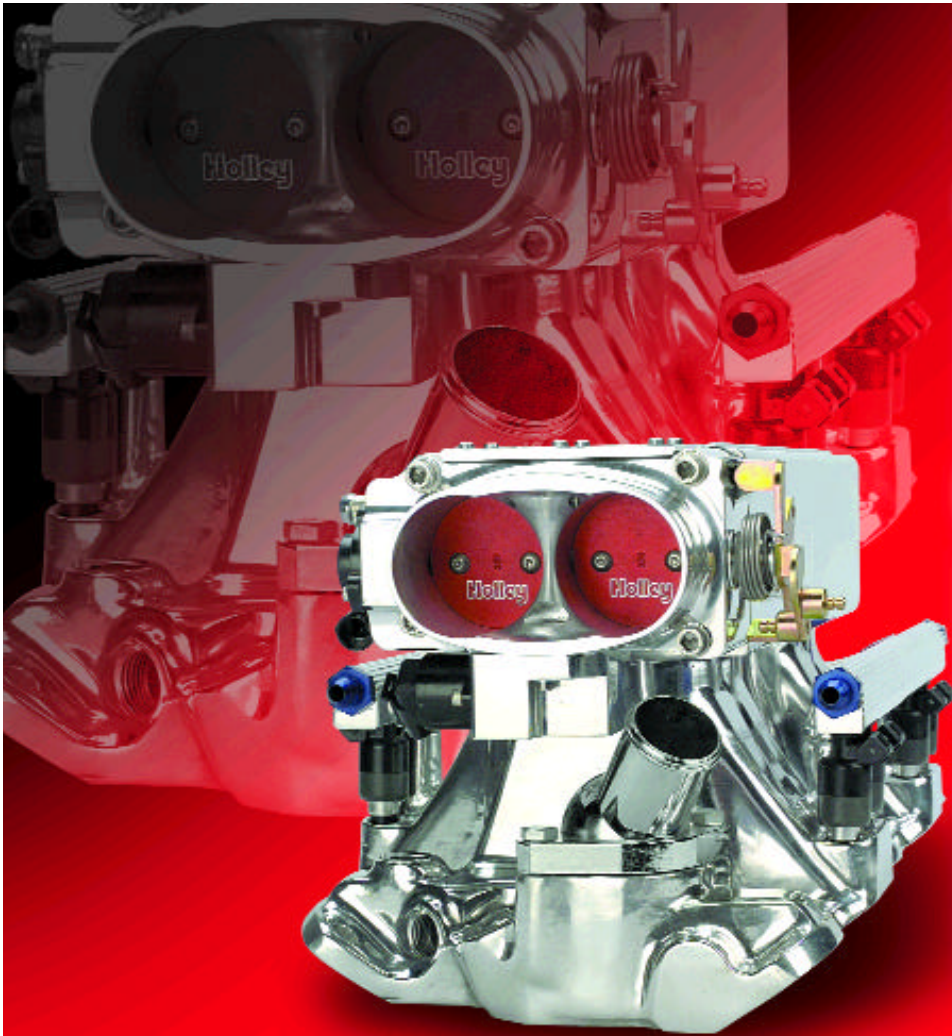

FUEL INJECTION

FUEL INJECTION

Section	Page #
Technical Information	94-99
Commander 950	
Overview	100,101
Engine Mgmt System Kits	102,103
MPFI Universal Kits	104
MPFI Dedicated Systems	106-109
Race Software Upgrade	114
MPI Service Parts	115-119
4 Bbl TBI Systems	122,123
2 Bbl TBI Systems	124
Auxiliary Injector Driver Kit	125

Section	Page #
Stealth Ram	
MPFI Systems	105
MPFI Power Pack Kits	113
MPFI Power Pack Kits	110-112
Pro-Jection TBI Systems	
2 Bbl TBI Systems	126
1 Bbl TBI Systems	127
TBI System Service Parts	128-134
Fuel Rails	135
Fuel Injectors	136

Fuel Injection

Terms and Definitions of Fuel Injection Management Systems

Throttle Body Assembly (TBA) — The throttle body assembly (also called air valve), controls the airflow to the engine through one, two or four butterfly valves and provides valve position feedback via the throttle position sensor. Rotating the throttle lever to open or close the passage into the intake manifold controls the airflow to the engine. The accelerator pedal controls the throttle lever position. Other functions of the throttle body are idle bypass air control via the idle air control valve, coolant heat for avoiding icing conditions, vacuum signals for the ancillaries and the sensors.

Fuel Injector — There are basically three approaches in delivering the fuel to the engine:

- Above the throttle plate as in throttle body injection
- In the intake port toward the intake valves as in multi-port injection or central multi-port injection.
- Directly into the combustion chamber as in gasoline direct injection systems (GDI).

The fuel injector is continuously supplied with pressurized fuel from the electric fuel pump. The pressure across the metering orifice of the injector is maintained constant by the fuel pressure regulator. The fuel injector is an electromagnetic valve that when driven by the ECU delivers a metered quantity of fuel into the intake manifold (or combustion chamber in the GDI system). The ECU controls the fuel flow by pulse width modulation. The time the injector is driven into an open condition is determined by the following sensor inputs:

- Engine RPM
- Throttle position (TPS)
- Manifold absolute pressure or mass air flow
- Engine coolant temperature
- Oxygen sensor feedback voltage
- Intake air charge temperature
- Battery voltage

Central Point Injection System (CPI) — Electronic fuel Injection system consisting on a single fuel injector mounted in the throttle body.

Digital Fuel Injection (DEFI or DFI) — Electronic fuel injection system controlled by digital microprocessors as opposed to earlier systems that were of analog design. The analog input signals to the microprocessor are converted from analog to digital before being processed.



Throttle Body Injection (TBI) — In TBI systems the throttle body assembly has two major functions: regulate the airflow, and house the fuel injectors and the fuel pressure regulator. The choices of throttle bodies range from single barrel/single injector

unit generally sized for less than 150 HP to four barrel/four injector unit capable of supporting fuel and air flow for 600 HP. The injectors are located in an injector pod above the throttle valves. The quantity of fuel the injector spray into the intake manifold is continuously controlled by the ECU. Most of the TBI systems use bottom fed fuel injectors.

Multi-Point Fuel Injection (MPFI) — In the multi point fuel injection system an injector is located in the intake manifold passage. The fuel is supplied to the injectors via a fuel rail in the case of top fed fuel injectors and via a fuel galley in the intake manifold in the case of bottom fed fuel injectors. MPFI systems provide better performance and fuel economy as compared to TBI. Most of the MPFI systems use one injector per cylinder but in certain applications up to two injectors per cylinder are used to supply the required fuel for the engine.

Central Multi-port Fuel Injection (CMFI) — This is a variation of MPFI system but in this case the injectors (usually one per cylinder) are located in a plastic molded pod and the fuel is distributed to the intake ports via a polymeric hose. To avoid fuel distribution variations a fuel pressure activated poppet valve is installed at the end of the hose. The injectors are activated via the ECU in a similar fashion as in the MPFI fuel systems.

Tuned Port Injection (TPI) — A TPI is a fuel/air management system that has a tuned induction system to optimize airflow to each cylinder. This system was developed to obtain the broadest possible torque curve. A single throttle body and one injector per cylinder are used in this configuration. The intake manifold incorporates long runners whose length is tuned to the desired torque curve. For low and mid range torque longer runners are utilized in this application.

Direct Fuel Injection (DFI) — In a direct fuel injection system one injector is located in the cylinder head for each cylinder. The high-pressure fuel (single fluid) or low-pressure air/fuel mixture (dual fluid) is metered directly into the combustion chamber when the electromagnetic valve is activated by the ECU. This fuel injection system offers the latest in engine management systems and offers the best in engine performance, low exhaust emissions and fuel economy.



Electronic Control Unit (ECU) — The function of the ECU is to “tweak” or “fine tune” the engine operation to obtain the most complete and efficient combustion process. The ECU microprocessor receives input signals from various sensors from the engine and generates specific outputs to maintain optimum engine performance. The engine operating modes controlled by the ECU is the following:

- Cold and hot start
- Acceleration enrichment
- Battery voltage compensation
- Deceleration cut/off or leanment
- Run mode (open loop or closed loop)

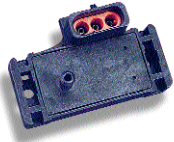

Manifold Absolute Pressure Sensor (MAP) — The MAP sensor is a three-wire sensor located on or attached to the intake manifold. The function of this sensor is to measure the changes in the intake manifold air pressure and gener-

ates an electric signal that is proportional to the change of pressure. This signal is fed into the ECU and is used to:

- Adjust the fuel delivery
- Spark ignition calculations
- Barometric pressure readings upon starting the engine

Mass Air Flow Sensor (MAF) — The mass air flow sensor is positioned in the air intake duct or manifold and measures the mass of incoming air. From this acquired data the ECU calculates the required fuel for the specific air mass flow rate. The MAF works on the hot wire or hot film concept. The hot wire/film is maintained at a constant calibrated temperature. The passing air cools down the hot wire/film and the added energy required to maintain the calibrated temperature is directly proportional to the mass of air passing by the hot wire. The MAF also compensates for humidity as humid air, denser or cooler, absorbs more heat from the sensor, requiring more current to maintain the calibration temperature.

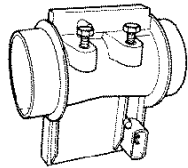

The hot wire/film is maintained at a constant calibrated temperature. The passing air cools down the hot wire/film and the added energy required to maintain the calibrated temperature is directly proportional to the mass of air passing by the hot wire. The MAF also compensates for humidity as humid air, denser or cooler, absorbs more heat from the sensor, requiring more current to maintain the calibration temperature.

Throttle Position Sensor (TPS) — The TPS is a three-wire sensor that is mounted on the throttle body assembly and is actuated by the throttle shaft. The TPS is basically a variable resistor (potentiometer) that sends a voltage signal to the ECU that is proportional to the throttle shaft rotation. When the throttle shaft is open the sensor emits a high voltage

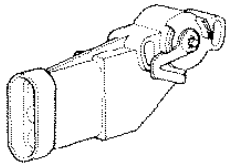

signal and when the throttle shaft is closed it emits a low voltage signal. The voltage signal from the TPS changes between 0.45 V at idle to 4.5 to 5.0V at wide open throttle.

Open Loop — Open loop defines the engine operation where the fueling level is calculated by the ECU with only the input signals from the throttle position sensor (TPS), from the coolant and/or air charge temperature, and from the manifold absolute pressure (MAP) or the mass air flow sensor (MAF).

Closed Loop — Closed loop defines the engine operation where the fueling level is calculated and corrected by the ECU based on the voltage signal from the O₂ sensor. When the O₂ sensor emits a voltage signal above 0.45V due to a rich mixture in the exhaust manifold, the ECU reduces the fueling level by reducing the pulse width of the injector. The O₂ sensor voltage is the feedback that modifies the fuel control program that is based on other signals.

Idle Air Control Valve (IACV or IAC) — The IAC is located in the throttle body of the TBI, MPFI and CMFI systems. The valve consists of a stepper motor that adjusts the position of its pintle to vary the bypass air during idle and off idle conditions.

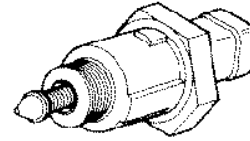

During the closed throttle condition (idle), the ECU constantly compares actual engine speed with the programmed desired engine speeds. Discrepancy between these two values result in activation of the stepper motor increasing or decreasing the bypass air around the throttle plate(s) until desired engine speed is achieved. The following input signals or conditions determine the position of the valve:

- Throttle position sensor
- Engine load (MAP/MAF, A/C compressor, power steering pressure switch, gear selection)
- Battery Voltage
- Engine coolant temperature

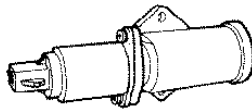

Throttle Air Bypass Valve — The throttle air bypass valve is located on the throttle body of engine fuel management systems. This solenoid valve allows additional bypass air when the engine is subjected to certain load conditions or cold starts.

Air Charge Temperature Sensor — The air charge sensor is located in the engine air intake to sense the air induced into the engine manifold. The sensor consists of a thermistor, which generates a voltage signal, that is proportional to the air temperature. This voltage signal is used by the ECU to calculate the air density and using these results to adjust the fueling levels for a particular engine load. Other functions of the air temperature signal are:

- Adjust fueling during cold start
- Activation of the EGR valve
- Modify spark advance
- Regulate acceleration enrichment

CARBURETORS
FUEL INJECTION
THROTTLE BODIES
FUEL PUMPS
INTAKE MANIFOLDS
SPRINKLERS
CYLINDER HEADS
SYSTEMS
WATER PUMPS
BRESS-UP
BATTERY
STREET & TRUCK AIRBENS
PUMP-SCALE
INDEX/ALPHABETIC

Fuel Injection

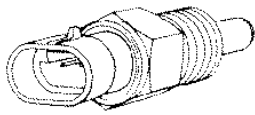

Coolant Temperature Sensor

— The coolant temperature sensor is a two-wire sensor that is threaded into the engine block and is in direct contact with the coolant. The function

of this sensor is to generate a signal that the ECU uses to adjust the fueling levels required for the operation of the engine and operate ancillaries. The thermistor contained in the sensor generates an electric signal that is proportional to the coolant temperature. At low temperatures the resistance is high (3800 ohms) generating a 5-volt signal in the ECU. At normal engine operating temperatures the resistance of the sensor is low (180–200 ohms) which generates 1–2 volt signal in the ECU. Other functions of the coolant temperature signal are:

- Idle speed adjustment via the IAC
- Modify spark advance
- Electric cooling fan operation
- Activation of the EGR
- Torque converter clutch application

Oxygen Sensor — The oxygen sensor is located in the exhaust manifold and its function is to measure the oxygen content in the exhaust gases. The sensor is an electrochemical cell, which develops a voltage signal between its two electrodes that is proportional to the oxygen content in the exhaust gases. The oxygen sensor adjusts and maintains an optimum air fuel mixture to control the exhaust emission and the fuel economy. When the oxygen content in the exhaust is high due to a lean mixture the output voltage of the sensor is close to zero. If the fuel air mixture is on the rich side, the oxygen content in the exhaust is low and the output voltage of the sensor approaches 1.0 volts. There are three types of oxygen sensors:



• One wire O₂ sensor (not heated)

• Three wire O₂ sensor (heated)

• Four wire O₂ sensor (heated)

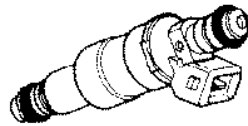
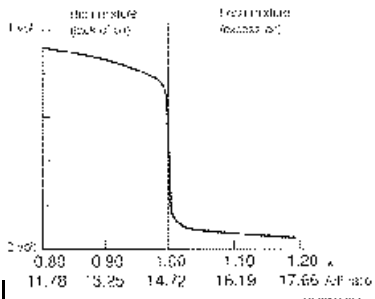

Top-Fed Fuel Injector

— When the ECU activates this electromagnetic valve, the injector meters and atomizes fuel in front of the intake valve. The fuel enters the top and is discharged via the metering

orifice at the bottom at high pressure. The spray geometry and cross sectional area is specific to the engine application. In general there are four major spray patterns:

- Pencil stream. Solid stream narrow angle spray.
- Split pencil stream. Two solid streams narrow angle sprays usually used in multi valve cylinder applications.
- Bend spray. Solid stream narrow angle spray being discharged in an angle with respect to the injector center axis. This application is used in engine applications where the injector package does not allow alignment of the injector axis with the spray target center axis.
- Oblong spray. This spray geometry consists of an elliptic or oblong cross-sectional area of the spray. This application is used in engine applications where the spray target requires a specific spray pattern.

Bottom Fed Fuel Injector

— This electromagnetic valve meters fuel into the intake manifold in proportion to the air flowing into the engine. When the valve is energized the electromagnetic force generated by the solenoid lifts the pintle/ball from the seat. Fuel under pressure is then injected into the throttle body bore or the intake port. The spray configuration is application dependent. For throttle body injection a hollow conical spray is required while for port injection a narrow pencil stream is preferred to avoid wall wetting.

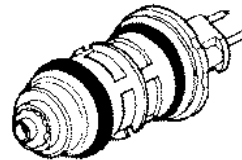

High Impedance Injectors — Most injectors can be divided into two major categories: high impedance 12 to 16 Ohms and low impedance 1.2 to 4.0 Ohms. The high impedance injectors are used with ECUs that are designed with saturation drivers. The advantage of using saturation drivers is that the currents running through the ECU circuits and the injectors are relatively low thus generating less heat. The disadvantage of saturation drivers is that the driver has a slower response time, which could affect the full utilization of such a system at very high engine RPM.

Low Impedance Injectors — The low impedance injectors are designed to be run with an ECU that employs peak and hold drivers (also called current sensing or current limiting drivers). The current ratio (peak to hold) is generally 4:1 and the most common drivers available are 4 A peak/1 A hold or 2A peak/ 0.5Ahold. The peak current is generated to overcome the inertia of the closed valve and once the valve is open the driver cuts down to 1/4 of the peak current to hold the injector open until the end of the metering event. Low impedance injector designs are mostly used in high flow applications.



Electric In-line Fuel Pump — The function of the electric fuel pump is to deliver pressurized fuel to the fuel injection system. The ECU activates the fuel pump relay to operate the fuel pump when the ignition switch is in the On or start position. The pumps are designed to match certain flow and pressure specification for the engine application. In TBI applications the fuel pump must supply enough fuel flow for the engine WOT output at 15 to 20 psi. In multi-port applications the fuel pump must be able to supply enough fuel at full engine load to maintain at least 43.5 psi at the fuel rail. At idle the fuel pressure regulator must be able to return the excess fuel to the tank and maintain the required system pressure. Most of the cars prior to 1987 use an in-line external electric fuel pump.



Electric In-tank Fuel Pump — Almost all car applications after 1987 designed their fuel pump assembly inside the fuel tank.

The advantage of having the fuel pump in the fuel tank is mainly lower noise, lower

potential leakage problems, less mounting sensitivity of the pump with respect to lift of fuel from the tank is minimized. The in-tank pump went through several designs evolving from a simple “pump on a stick” to a complex in-tank fuel sending modules. The new designs combine the high-pressure electric fuel pump, noise isolation and a fuel level sensor into one compact modular package. This new design also helps reducing hydrocarbon emissions. The hot gasoline returning from the fuel system is returned to the reservoir surrounding the fuel pump. By returning the hot fuel to the reservoir heating of the bulk fuel in the fuel tank is avoided, thus reducing the evaporation of the high volatile portions in the fuel. At present all fuel tank modules are designed and serviced as a complete unit. If the pump or fuel level sensor fails the entire unit will have to be changed.

Fuel Pump Inlet Filter — The function of this filter is to eliminate any impurities that might harm the fuel pump. In the in-line fuel pump type this filter is external to the fuel tank and is in a replaceable cartridge filter. In the in-tank fuel pumps the fuel filter is in the form of a sock and is directly attached to the pump in the “pump on a stick” version and attached to the fuel pump module in the module version.

Main Fuel Filter — The function of this filter is to eliminate any contaminants after the fuel pump. These are either small enough to pass through the fuel filter of the pump inlet or are generated by the fuel pump. This fuel filter is also of the cartridge type but is designed to sustain much higher fuel pressures that the fuel pump inlet filter.

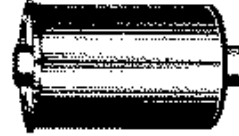

Fuel Pressure Regulator — Fuel system pressure is maintained by the regulator, while excess fuel is returned to the fuel tank. The regulator consists of two chambers separated by a diaphragm assembly. On the fuel side of the diaphragm a throttling valve is employed to expand or restrict fuel flow as the fuel pressure fluctuates. The other side contains a spring with an adjustment screw that is set at the factory for correct system pressure and flow. This chamber is connected to the intake manifold in MPFI systems to reference the vacuum in the manifold during engine operation. This pressure reference is required to maintain a constant differential pressure across the metering orifice of the fuel injector.



CARBURETORS
FUEL INJECTION
THROTTLE BODIES
FUEL PUMPS
INTAKE MANIFOLDS
SPRINGS
CYLINDER HEADS
SPARKPLUGS
WATER PUMPS
BELTDRIVE
BATTERY
STREET & TRUCK AIRBLEN
POINT-OF-SALE
INDEX/ABBREVIATION

Fuel Injection

THE ENGINE APPLICATION AND THE SELECTION OF YOUR FUEL MANAGEMENT SYSTEM COMPONENTS.

Injector Fuel Flow

Engine output is in direct relation with fuel supplied to the engine, however installing injectors, which are too big, will not make more power. It is therefore very important to match the fuel injector flow characteristics to specific engine applications. Matching the fuel flow characteristics of fuel injectors is as important as matching the carburetor jets for a specific engine application. The fuel flow of the injectors and the carburetor has to be matched to the air flow requirements of the engine over a broad RPM operating range.

In the carburetor the operating range is usually divided into three sub-ranges: idle, mid-range and power. Three distinct fuel circuits supply the fuels for these three ranges. In MPFI systems one single injector has to cover all three ranges for individual cylinders from 500 RPM at idle to 8000 at WOT. The operating range in fuel injectors is normally referred to as the dynamic range of the injector. An injector with a wide dynamic range is capable not only to potentially cover several engine applications but also is a very sought after metering tool for high performance applications.

The dynamic range must encompass the minute quantities of fuel required at idle conditions and the large quantities of fuel required at maximum engine output. It must also cover the required fuel amounts during transient response. The dynamic range of the fuel injector is further stressed in turbo charged applications because of the additional fuel required due to the higher engine air mass flow rates generated by the turbocharger.

The following equation sizes fuel injectors for specific engine applications.

Injector Static Flow Rate [lb/hr] = (Engine HP * BSFC) / (Number of injectors * DC of Inj.)

Engine HP = Realistic HP output estimate of the engine

BSFC = Brake Specific Fuel Consumption [lb/HP*hr].
Good approximation 0.50

Duty Cycle of Injector = Maximum opening time of injector/cycle time.

Maximum Duty Cycle= 0.90

Example:

Engine HP = 400HP

Number of Injectors = 8

Injector Static Flow Rate [lb/hr] = (400 * 0.50)/(8 * 0.90) = >27.78 b/hr

Note: If the application requires a static flow rate that falls in between two available injectors always use the next injector with the higher flow rate.

For the example above if only 25 lb/hr and 30 lb/hr injectors are available, choose 30lb/hr injectors.

Fuel pressure

In certain occasions matching of the injectors' fuel flow for a specific engine application cannot be done due to injector availability or the fuel flow step between the available injectors is too large. Since the fuel injector is a pressure/time-metering device, increasing the fuel pressure can increase the fueling level. Increasing the fuel pressure is limited mainly to four factors: burst pressure of the components in the fuel system, increase of opening time of the injector, reduced life expectancy of the fuel system components and limitations of the fuel pump. Most injectors are limited to a burst pressure of 125 psi. Reducing the fuel pressure to match the required fuel flow can be done but lower fuel pressures affect the atomization efficiency of the fuel injector nozzle. To project potential fueling levels by changing the fuel pressure, the following equation can be used:

$$M1/M2 = P1 / P2$$

M1 = rated mass flow rate of the injector at fuel pressure P1 in lb/hr

M2 = new mass flow rate of the injector at fuel pressure P2 in lb/hr

P1 = existing fuel pressure setting in psi

P2 = new fuel pressure setting in psi

Example:

Rated mass flow rate M1 = 30 lb/hr

Existing fuel pressure P1 = 43.5 psi

Required fuel mass flow rate M2 = 35 lb/hr

$$P2 = (M2/M1)^2 * P1$$

$$P2 = (35/30)^2 * 43.5$$

$$P2 = 59.21 \text{psi} = >60 \text{psi}$$

To obtain a fueling level of 35 lb/hr the system pressure has to be increased to 60 psi.

After increasing the fuel pressure to obtain certain engine output, idle, off-idle and light load condition will have to be re-tested. Increasing the fueling level at the upper end, requires the fuel injector to run at smaller pulse widths at idle conditions. When running at pulse widths smaller than 1.8 ms the injector might be running in the non-linear portion of its dynamic range. Such condition can lead to engine "hunting" during idle to hesitation during off-idle conditions.





Proper Fuel Injector Selection Information

Choosing the proper fuel injector size is critical for the successful use of an electronic fuel injection system whether it be a TBI or Multi-port system. If an injector is too small, not enough fuel will be available when tuning an engine and damage can result. If an injector is selected that is much larger than is needed, the injector pulse width (time the injector is open) at idle may be too low and tuning problems at idle may occur.

Use the following information as a guide for selecting the correct injectors for an engine:

Formulas used to determine injector size:

$$\text{Injector Size} = \frac{(\text{Engine HP (Flywheel)}) \times (\text{BSFC})}{(\# \text{ of injectors}) \times (\text{Duty Cycle})}$$

Injector Size Flow rate in lbs/hr

Engine HP Maximum horsepower at the flywheel

BSFC Brake Specific Fuel Consumption (BSFC) is the lbs. of fuel an engine consumes per HP per hour. It is simply a measure of how efficiently an engine is at converting fuel to horsepower. It is very important to use a BSFC number that is close to your actual number. If it is not, the injector will be too small or larger than is necessary.

General guidelines when choosing a BSFC number:

Low to medium performance street engines: 0.50-.55
 Performance engines with good cyl. heads: 0.45-.50
 Race engines with very efficient cyl. heads: 0.38 - 0.45
 Supercharged and Turbocharged engines: 0.55 - 0.65

Supercharged and Turbocharged engines run at richer air/fuel ratios that raise the BSFC number. They require larger injectors for the same horsepower as a naturally aspirated engine.

Add 0.05 for marine applications, as they need to run richer than a comparable automotive application due to continuous wide open throttle use.

Duty Cycle The duty cycle is the maximum amount of time you want the injectors to be open at a certain horsepower and injector size. Under most circumstances you don't want an injector to be open more than 90% of the time at the most. Marine applications shouldn't exceed 80%. Injectors are rated at 100% duty cycle (static flow).

Later on if you want to increase the the engine HP, take that into account when entering the HP number.

When calculating injector size, round up to the next nearest size needed. For example if you calculate 26 lb/hr and have a 24 lb/hr and a 30 lb/hr to choose from, select the 30 lb/hr injector.

Examples

400 HP street engine
 Number of injectors = 8

$$\text{Injector size} = \frac{(400 \text{ HP}) \times (0.5 \text{ BSFC})}{(8 \text{ injectors}) \times (0.9)} = 27.7 \text{ lb/hr}$$

600 HP Supercharged engine
 Number of injectors = 8

$$\text{Injector size} = \frac{(600 \text{ HP}) \times (0.57 \text{ BSFC})}{(8 \text{ injectors}) \times (0.9)} = 47.5 \text{ lb/hr}$$

The following chart provides maximum horsepower levels based on injector size and various BSFC values. Note that this is at 100% duty cycle and 43.5 psi; raising the fuel pressure will increase the maximum horsepower.

Inj. Size	Max. HP at given BSFC (100% duty cycle, 43.5 PSI)				
	0.4	0.45	0.5	0.55	.06
14	280	250	225	203	186
19	380	337	304	276	253
24	480	426	384	349	320
30	600	533	480	436	400
36	720	640	576	523	480
42	840	746	672	610	560
50	1000	888	800	727	666
55	1100	977	880	800	733
65	1300	1155	1040	945	866
75	1500	1333	1200	1090	1000
85	1700	1511	1360	1236	1133
95	1900	1688	1520	1381	1266

- CARBURETORS
- FUEL INJECTION**
- THROTTLE BODIES
- FUEL PUMPS
- MARINE MANIFOLDS
- SPRINKLERS
- CYLINDER HEADS
- SYSTEMS
- WATER PUMPS
- BRESS-UP
- BATTERY
- STREET & TRUCK AIRBLEN
- PUMP-UP
- INJECTOR VARIANTS

Fuel Injection

Commander 950™ ECU Overview

The Holley Commander 950 ECU provides the customer with a high level of tuning flexibility to control engines from mild to wild. From stock, naturally aspirated engines, to high horsepower supercharged engines, the Commander 950 gives you the power to precisely tune all functions of an engine.

The Commander 950 allows for real-time tuning of all parameters. The Windows-based software is simple to use for the beginner and has all the features necessary for experienced tuners.

Features and Engine/Hardware Compatibility

- Works with 4, 6 (even fire), and 8 cylinder engines
- Can operate as a speed density system
 - Uses engine vacuum to sense engine load
 - Best for street driven vehicles and forced induction engines
 - Achieves optimum response and driveability
- Can operate in Alpha-N mode
 - Uses throttle position as indication of engine load
 - Use with engine with low manifold vacuum due to radical cams
- 16 x 16 Fuel and Ignition timing maps
- Compatible with 1, 2, or 3 bar MAP sensors
 - Naturally aspirated engines
 - Blown and turbocharged engines
- Compatible with GM and Chrysler IAC motors for best idle stabilization
- Compatible with GM knock sensor
- Operates in open and closed loop
 - Full control of closed loop parameters
- Work with port fuel injection
 - Controls up to 8 high impedance injectors
 - Controls up to 4 low impedance injectors
 - Controls 8 low impedance injectors with the addition of PN 534-122
- Works with throttle body fuel injection
 - Controls throttle body with progressive or 1:1 linkage
- Full tuning for:
 - Startup and warm-up fuel enrichment
 - Acceleration fuel enrichment based on MAP and TPS sensors
 - Programmable RPM scale
- Timing control function can be achieved through the use of:
 - Small cap computer controlled GM HEI (stock GM or Holley pn 890-160)
 - Large cap computer controlled GM HEI
 - Ford TFI distributor
 - Magnetic crank trigger
 - Hall effect crank trigger
 - Programmable fuel pump and cooling fan control
 - Integrated rev limiter
 - A data-logger is included with the software.
 - ECU size is 5.5" x 4.75" x 2.0"





COMMANDER 950™ SOFTWARE

The Holley software included is Windows-based. It is designed for beginning users or expert tuners. The software is compatible with Windows 3.1, 95, 98, 2000, ME, and XP operating systems. A computer with a 9-pin serial port is required. The software allows real-time tuning whether on the dyno or tuning on the street.

All sensor data is viewable from both the fuel and ignition timing maps which makes tuning easier. The fuel and ignition timing maps can both be viewed in graphical form, which helps to better visualize the data. Hot keys allow for quick navigation between screens. Other features such as warning the user when a fuel map number is entered that drives the injectors static makes tuning safer.

A comprehensive, step-by-step tuning manual is included, along with many base maps to get you started and assure success.

A professional level data-logger is included for evaluating on-track performance.

A copy of the comprehensive 100 page manual can be downloaded at holley.com

Fuel Map

Nitrous Enabled
 Nitrous Sol. On
 Fuel Pump On
 Fan On
 Power Tuner Active
 Idle Spark Active
 Park/Neutral Park
 O2 Lx Off
 Rev Limiting
 A/C Request
 Park/Neutral

Off line: RPM [0], MAP [0], MAT Mod [0], Spk Adv [0], TPS [0], Clt Mod [0], IAC Position [0], MAT (F) [0], Alt Mod [0], dTPSt [0], O2 (V) [0], V Bat [0], Inq PW [0], dMAPdt [0], V Bat [0], Inq PW [0], Coolant (F) [0], Duty Cycle [0], GM HEI [0]

100	90	90	95	100	110	125	130	130	135	135	135	135	130	120	120	115
94	100	100	105	110	120	125	130	130	135	135	135	135	130	130	130	125
88	95	95	100	105	110	115	120	125	125	125	125	125	120	120	120	115
81	70	70	75	75	78	85	90	94	99	100	99	95	90	90	90	90
75	60	60	65	66	69	75	80	82	90	90	90	90	90	90	90	80
69	50	50	55	59	66	72	75	81	85	85	85	85	85	85	85	75
63	40	46	50	56	61	67	74	75	80	80	75	75	75	75	75	75
56	40	40	48	53	60	64	72	72	74	74	74	74	74	74	74	74
50	37	37	37	47												
44	35	34	36	39												
38	23	33	36	37												
31	19	28	31	31												
25	19	22	24	25												
19	19	17	21	25												
13	22	15	15	4												
6	22	15	15	3												

Acceleration Enrichment

Asynchronous Acceleration Enrichment Tables

Pulse Width - Rate of change of TPS	1.504	1.808	2.0	2.0	2.496	2.496	2.992	2.992	3.504	3.504	4.08	4.0	4.0	4.0	4.0	4.0
-------------------------------------	-------	-------	-----	-----	-------	-------	-------	-------	-------	-------	------	-----	-----	-----	-----	-----

AE correction vs. Coolant Temperature (%)
 AE correction vs. TPS (%)
Synchronous Acceleration Enrichment Tables
 Rate of change of MAP Sensor
 Acceleration Decay Rate
 AE of Map vs. Coolant Temperature (%)

Startup Enrichment

Cranking Pulse Width (mSec)	20.5	20.5	20.5	20.5	16.4	16.4	11.0	5.6	4.9	4.9	4.9	4.9	4.9	4.9	4.9	4.9
Afterstart Enrichment (%)	150.0	150.0	150.0	138.3	129.7	121.1	112.5	103.9	100.0	100.0	100.0	100.0	100.0	100.0	100.0	110.2
Afterstart Holdoff (Rev.)	5	6	6	6	8	8	9	9	9	9	9	9	9	9	9	9
Afterstart Decay Rate (1% /Rev.)	5	5	11	11	11	11	11	11	11	11	11	11	11	11	11	11
Auto Prime 7mSec Pulse Count	8	8	8	8	8	8	6	6	6	6	6	5	5	5	4	4
Engine Temperature (F)	0	11	32	41	54	66	75	87	98	110	121	138	156	180	212	235

NOTE: Downloadable base fuel maps are available at www.holley.com

Tech Line: 270-781-9741

101

- CHARACTERISTICS
- FUEL INJECTION**
- THROTTLE BODIES
- FUEL PUMPS
- INTAKE MANIFOLDS
- SPRINGS
- CYLINDER HEADS
- SPARKPLUGS
- WATER PUMPS
- BRESSUP
- BATTERY
- STREET & TRACK ADAPTERS
- POINT-TO-POINT
- INDEX/ALPHABETIC

Fuel Injection

COMMANDER 950™ ENGINE MANAGEMENT SYSTEM KITS

These Holley kits are intended to replace and upgrade existing fuel injection electronics or to provide a state-of-the-art electronic control module, if none is currently available. The Holley Commander 950 is the most powerful and capable ECU available on the market today. Capable of driving up to 8 high impedance and 4 low impedance injectors, the Commander 950 can provide all the power and sophistication required for any street or strip fuel injected motor. These Holley engine management system kits contain the Commander 950 ECU, wiring harness and sensors, where applicable, that you'll need to make a customized fuel injection installation.

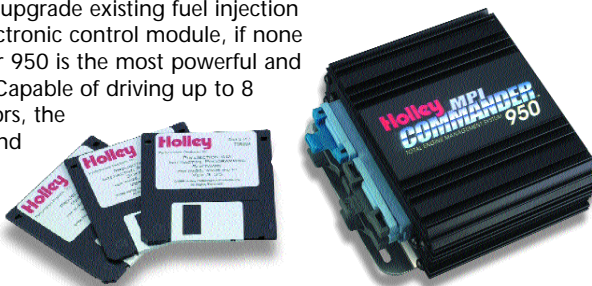

NOTE: These systems are designed only for fuel and spark management. Items such as cruise control, transmission control, AC, ABS, etc are not controlled by the Commander 950.

Application	Part #
Holley 1D/2D Pro-Jection systems (replaces and upgrades existing Pro-Jection electronics)	950-113 (B)
Holley 4D and 4Di Pro-Jection systems (replaces and upgrades existing Pro-Jection electronics)	950-100 (B)
Holley MPI Pro-Jection II systems (replaces and upgrades existing Pro-Jection electronics)	950-103 (B)
1985-92 GM TPI (tuned port injection) engine applications	950-101 (B)
1992-97 GM LT1/LT4 engine applications (requires a custom crank trigger installation)	950-105 (B)
1986-95 Ford 5.0L EFI V8 engine applications	950-106 (B)
Universal V8 multi-point fuel injection	950-109 (B)
Universal V6 multi-point fuel injection	950-110 (B)
Universal 4cyl. & import multi-point fuel injection	950-104 (B)
Universal engine controller kit for customized applications (includes 20' long, non-terminated harness for cut-to-length flexibility)	950-115 (B)



COMMANDER 950™ ENGINE MANAGEMENT SYSTEM KITS

Service Parts

	Part #
Cable, communication, laptop computer Provides ECU to laptop computer connection	534-140
Distributor wiring harness adapter, Chevrolet HEI Small cap distributor	534-138
Distributor wiring harness adapter, Ford TFI	534-139
ECU, Commander 950 (except LS1 kit)	534-120
LS1 kit, P/N 950-102	534-176
Relay kit, cooling fan Includes relay and wiring for cooling fan	534-134
Sensor, knock, wiring connector kit Does not include module or sensor	534-159
Software, Commander 950 Mapping and set up	534-144
Wiring harness, injectors	
Universal 4 cyl. kit, P/N 950-104	534-153
Ford 5.0LV8 kit, P/N 950-106	534-131
Universal V6 kit, P/N 950-110	534-152
Universal V8 kit, P/N 950-109	534-133
Universal S/B V8 (over the fuel rail)	534-129
Universal B/B V8 (under the plenum)	534-130
Universal 4 cyl.	534-182
Wiring harness, Hall Effect sensor Provides wiring for Hall Effect sensor installation	534-177
Wiring harness, magnetic pick up Provides wiring for magnetic pick up installation	534-135
Wiring harness, main	
Used with kit, P/N 950-100	534-146
Used with kit, P/N 950-101	534-128
Used with kit, P/N 950-102	534-147
Used with kit, P/N 950-103	534-142
Used with kit, P/N 950-105	534-148
Used with kit, P/N 950-106	534-149
Used with kit, P/N 950-110	534-151
Used with kit, P/N 950-113	534-158
Used with kit, P/N 950-114	534-157
Used with kit, P/N 950-115	534-143
Used with kit, P/N 950-117	534-156

Accessories

Race software upgrade for Commander 950™
A host of new features adds to the already impressive Commander 950 system to make this truly one of the best systems on the market.



(see page 114)

Auxiliary Injector Driver Kit

Designed to work with ECUs (like the Holley Commander 950) that have four (4) "peak to hold drivers". What this module does is expand the ECU's capability to control eight (8) "peak to hold drivers", allowing the use of eight (8) low impedance injectors. With this additional capability, running either a 2x4 throttle body set-up or 8 low impedance injectors in a multi-point system is possible.



(see page 125)

CHARACTERS

FUEL
METERING

THROTTLE
BODIES

FUEL PUMPS

INTAKE
MANIFOLDS

SPRINKLERS

CYLINDER
HEADS

SYSTEMS

WATER
PUMPS

DRESS-UP

BATTERY

STREET & TRUCK
AERIALS

POINT-TO-POINT

INDICATOR
LAMP

(B) Not legal for sale or use in California on any pollution controlled motor vehicles.

1 2 or 3 See page 2 for symbol explanation.



Fuel Injection

COMMANDER 950™ MULTI-POINT FUEL INJECTION UNIVERSAL KITS

Install multi-port fuel injection on any engine!

System includes most components necessary to retrofit multi-port electronic fuel injection on nearly any vehicle. Just use your manifold of choice and you have a customized EFI motor.

NEW!

Part #	Kit Description
534-183(B) 	1000 CFM throttle body
534-184(B) 	2000 CFM throttle body

Kits include:

- Commander 950 ECU
- Pre-terminated wiring harness
- 1000 or 2000 CFM billet aluminum throttle body
- Billet aluminum fuel pressure regulator
- 8 injector bungs
- aluminum fuel rails
- MAP, coolant, air temperature, and oxygen sensors
- Software
- Comprehensive installation and tuning manuals

Additional requirements:

- Fuel injectors sized to application
- Fuel pump and filters sized to application
- Machining of supplied fuel rails
- Machining and welding of injector bungs and fuel rail hold-downs
- Plumbing
- New throttle cable bracketry

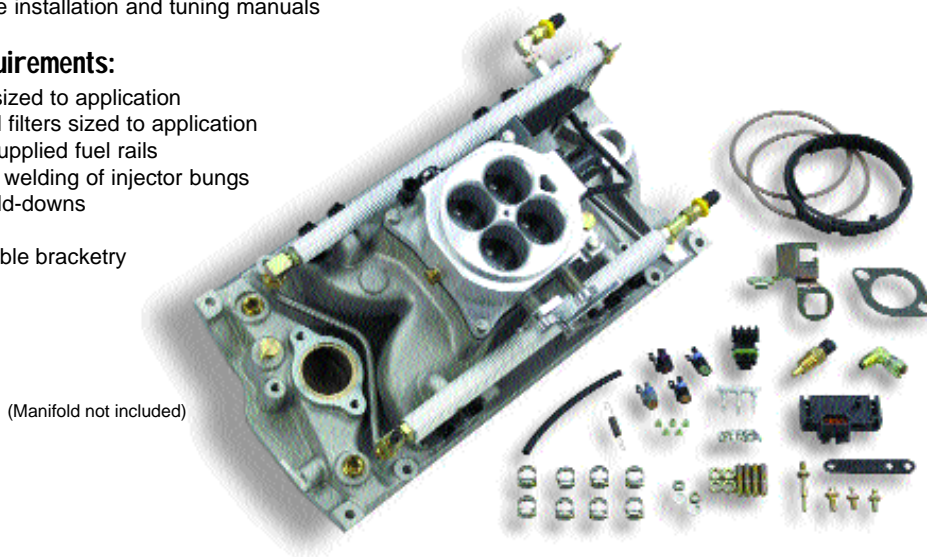

(B) Not legal for sale or use in California on any pollution controlled motor vehicles.

(C) Not legal for street use with a 4-barrel in California on vehicles equipped with a 2-barrel carburetor, for which there was no 4-barrel option.

  or  See page 2 for symbol explanation.



STEALTH RAM™ MULTI-POINT FUEL INJECTION SYSTEMS

Want to get “Oooos” and “Ahhhs” every time you open the hood? Want to feel real power every time you step on the loud pedal? Then you’d better get Holley’s new STEALTH RAM™ MPFI system on your street machine. Tunnel ram design helps to build power. The plenum and runner designs promote excellent mid-range torque along with outstanding high RPM power. Available polished finish helps you look good. Commander 950™ software and electronics helps you get down the road in no time.

STEALTH RAM™ MPFI systems are complete and include a 2x58mm billet throttle body. The following are available:

Part #	STEALTH RAM™ Kit Description	Horsepower Range*
91503201 ^(B)	Satin finish kit with 24 pph injectors	300 - 385
91504201 ^(B)	Satin finish kit with 30 pph injectors	385 - 480
91505201 ^(B)	Satin finish kit with 36 pph injectors	480 - 575
91506201 ^(B)	Satin finish kit with 42 pph injectors	575 - 670
91403201 ^(B)	Polished kit with 24 pph injectors	300 - 385
91404201 ^(B)	Polished kit with 30 pph injectors	385 - 480
91405201 ^(B)	Polished kit with 36 pph injectors	480 - 575
91406201 ^(B)	Polished kit with 42 pph injectors	575 - 670



(*) A brake specific fuel consumption (BSFC) of .45 and 90% duty cycle is used for the maximum horsepower recommendation.

System features:

- Fits early and late(**) model 23° Chevrolet cylinder heads
 - Computer controlled timing available using 1984-1996 GM external coil distributor (billet Holley version available under P/N 890-160).
 - Base maps for various combinations to get you started
 - Designed to use GM TPI throttle and transmission cables and brackets
- (**) Requires angled bolt spacers, P/N 90748

Systems include:

- Upper and lower intake manifolds
- 58mm billet throttle body
- Bright clear anodized aluminum fuel rails
- Fuel injectors
- Fuel pressure regulator
- 255 LPH fuel pump and fuel filters
- Commander 950™ ECU
- All wiring harnesses
- Software and communications cable
- TPS, MAP, coolant, air temperature and oxygen sensors
- Detailed installation and tuning manuals

Specifications:

- Height is 10-1/4"
- Shipping weight is approximately 45 lbs.



(B) Not legal for sale or use in California on any pollution controlled motor vehicles.

(C) Not legal for street use with a 4-barrel in California on vehicles equipped with a 2-barrel carburetor, for which there was no 4-barrel option.

or See page 2 for symbol explanation.

- CARBURETORS
- FUEL INJECTION**
- THROTTLE BODIES
- FUEL PUMPS
- INTAKE MANIFOLDS
- SPRINGS/SHOCKS
- CYLINDER HEADS
- SYNCHRONIZERS
- WATER PUMPS
- BRESS-UP
- BATTERY
- STREET & TRUCK ADAPTERS
- POINT-OF-SALE
- NEW/UPGRADES

Tech Line: 270-781-9741

105

Fuel Injection

COMMANDER 950™ MULTI-POINT FUEL INJECTION SYSTEMS

Commander 950 Multi-Point Fuel Injection Systems are intended for carbureted, non-emission, non-computerized Chevrolet small block and big block V8 engines. Ford small block V8 engines are not forgotten, as some very special systems are also available for them.

These are complete systems that are engineered to provide all the components and hardware needed for your custom installation. The intake manifold, billet throttle body, billet fuel rails, injectors and related miscellaneous parts are partially pre-assembled and tested prior to packaging. Holley takes this extra step in quality assurance to verify the performance, quality and integrity of the system.

With the addition of Commander 950 electronics, Holley multi-point fuel injection systems offer more in the way of features, more in the way of performance, more in the way of system capability, more in the way of outright good looks and more in the way of value! The product features, listed below, should explain this well enough.

Whether your engine is stock, crate or custom-built, a Holley Commander 950 multi-point fuel injection system can help maximize its performance characteristics and make your cruising times a lot more enjoyable.

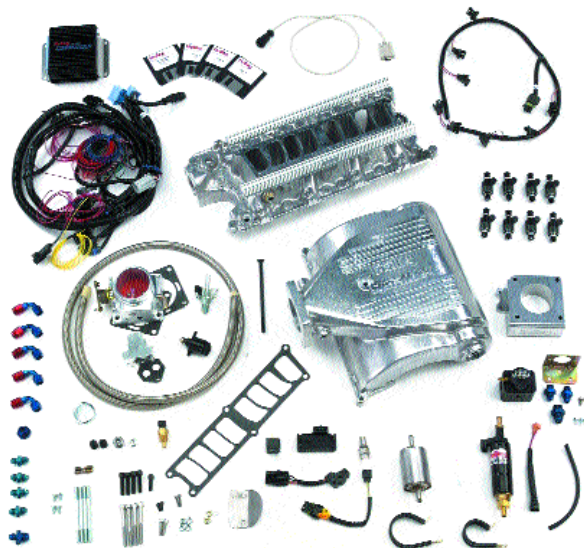

Ford system is shown

Features

- These stand-alone systems are partially pre-assembled at the factory and contain all components necessary for installation, including a detailed installation guide.
- Commander 950 ECU control functions are accessible with supplied Holley software and fully programmable with a personal laptop computer with WIN 3.1, '95, '98, NT.
- Throttle bodies available in the following styles:
 - 1000 CFM billet w/ 4-bbl square bore and 5" air horn
 - 2000 CFM billet w/ DOMINATOR flange
- Fits the following Chevrolet engines:
 - Small block w/ 23° standard port heads (early & late)
 - Small block w/ Vortec cylinder heads
 - Big block oval port heads
 - Big block rectangular port heads - including tall decks
- Fits Ford small block V8 engines.
- Sensors include: throttle position, MAP, engine and air temperature, exhaust oxygen and idle air control motor
- Wiring harness is designed for "plug-in" installation.
- Separate systems available for engines either naturally aspirated or force inducted, up to 14.7 PSI.

- Adjustable timing is available with any of the following distributors:
 - 1980-1/2 - 1990 GM 7-pin (coil-in-cap)
 - 1984 - 96 GM (external coil)
 - 1984 - later Ford 7-wire TFI

The Commander 950™ ECU's adjustable timing feature will also work with any CD ignition that does not have timing control (such as HPANNIHILATOR, P/N 800-100) if used with one of the above-listed distributors.

- Base fuel maps available off the Holley Web site.

Benefits

- Vastly improved fuel distribution and cylinder filling
- Excellent throttle response, driveability and fuel economy
- Impressive torque and horsepower gains over standard carburetion
- Superior idle, warm up and part-throttle driving characteristics

(A) Not legal for street use in California on vehicles originally equipped with 2-barrel carburetors for which there was no 4-barrel option.

(B) Not legal for sale or use in California on any pollution controlled motor vehicles.

1 2 or 3 See page 2 for symbol explanation.

106

www.holley.com



COMMANDER 950™ MULTI-POINT FUEL INJECTION SYSTEMS

HP RANGE	CFM	Throttle Body FLANGE	INJECTOR SIZE	SYSTEM PART NUMBER	
				In-Line Fuel Pump	In-Tank Fuel Pump
Naturally Aspirated Applications:		Chevrolet Small Block V8; early/late cylinder heads			
225 - 300*	1000	square flange	19 lbs./hr.	91002101 (B)	91002301 (B)
300 - 385*	1000	square flange	24 lbs./hr.	91003101 (B)	91003301 (B)
385 - 480*	1000	square flange	30 lbs./hr.	91004101 (B)	91004301 (B)
480 - 575*	1000	square flange	36 lbs./hr.	91005201 (B)	91005301 (B)
575 - 670*	1000	square flange	42 lbs./hr.	91006201 (B)	91006301 (B)
670 - 800*	1000	square flange	50 lbs./hr.	91007201 (B)	91007301 (B)
Naturally Aspirated Applications:		Chevrolet Small Block V8; Vortec cylinder heads			
225 - 300*	1000	square flange	19 lbs./hr.	91102101 (B)	91102301 (B)
300 - 385*	1000	square flange	24 lbs./hr.	91103101 (B)	91103301 (B)
385 - 480*	1000	square flange	30 lbs./hr.	91104101 (B)	91104301 (B)
480 - 575*	1000	square flange	36 lbs./hr.	91105201 (B)	91105301 (B)
575 - 670*	1000	square flange	42 lbs./hr.	91106201 (B)	91106301 (B)
670 - 800*	1000	square flange	50 lbs./hr.	91107201 (B)	91107301 (B)
Naturally Aspirated Applications:		Chevrolet Big Block V8; Std. Deck; Oval Port cylinder heads			
300 - 385*	1000	square flange	24 lbs./hr.	92003101 (B)	92003301 (B)
385 - 480*	1000	square flange	30 lbs./hr.	92004101 (B)	92004301 (B)
480 - 575*	1000	square flange	36 lbs./hr.	92005201 (B)	92005301 (B)
575 - 670*	1000	square flange	42 lbs./hr.	92006201 (B)	92006301 (B)
670 - 800*	1000	square flange	50 lbs./hr.	92007201 (B)	92007301 (B)
Naturally Aspirated Applications:		Chevrolet Big Block V8; Std. Deck; Rectangular Port Heads			
300 - 385*	1000	square flange	24 lbs./hr.	92103101 (B)	92103301 (B)
385 - 480*	1000	square flange	30 lbs./hr.	92104101 (B)	92104301 (B)
480 - 575*	1000	square flange	36 lbs./hr.	92105201 (B)	92105301 (B)
575 - 670*	1000	square flange	42 lbs./hr.	92106201 (B)	92106301 (B)
670 - 800*	1000	square flange	50 lbs./hr.	92107201 (B)	92107301 (B)
575 - 670*	2000	Dominator flange	42 lbs./hr.	92306201 (B)	92306301 (B)
670 - 800*	2000	Dominator flange	50 lbs./hr.	92307201 (B)	92307301 (B)

(*) A brake specific fuel consumption (BSFC) of .45 and 90% duty cycle is used for the maximum horsepower recommendation.

NOTE: Downloadable base fuel maps are available at www.holley.com.

(A) Not legal for street use in California on vehicles originally equipped with 2-barrel carburetors for which there was no 4-barrel option.

(B) Not legal for sale or use in California on any pollution controlled motor vehicles.

or See page 2 for symbol explanation.

CARBURETORS
FUEL INJECTION
THROTTLE BODIES
FUEL PUMPS
INTAKE MANIFOLDS
SPRINGS
CYLINDER HEADS
SPARKPLUGS
WATER PUMPS
BELTDRIVE
BATTERY
STREET & TRUCK AERIALS
POINT-TO-POINT
INDICATORS

Tech Line: 270-781-9741

107

Fuel Injection

COMMANDER 950™ MULTI-POINT FUEL INJECTION SYSTEMS

HP RANGE	CFM	Throttle Body FLANGE	INJECTOR SIZE	SYSTEM PART NUMBER	
				In-Line Fuel Pump	In-Tank Fuel Pump
Naturally Aspirated Applications:		Chevrolet Big Block V8; Tall Deck; Rectangular Port Heads			
300 - 385*	1000	square flange	24 lbs./hr.	92203101 (B)	92203301 (B)
385 - 480*	1000	square flange	30 lbs./hr.	92204101 (B)	92204301 (B)
480 - 575*	1000	square flange	36 lbs./hr.	92205201 (B)	92205301 (B)
575 - 670*	1000	square flange	42 lbs./hr.	92206201 (B)	92206301 (B)
670 - 800*	1000	square flange	50 lbs./hr.	92207201 (B)	92207301 (B)
575 - 670*	2000	Dominator flange	42 lbs./hr.	92406201 (B)	92406301 (B)
670 - 800*	2000	Dominator flange	50 lbs./hr.	92407201 (B)	92407301 (B)
Naturally Aspirated Applications:		Ford 5.0L V8			
225 - 300*	65mm	Ford 5.0L EFI	19 lbs./hr.	94002101 (B)	94002301 (B)
300 - 385*	65mm	Ford 5.0L EFI	24 lbs./hr.	94003101 (B)	94003301 (B)
300 - 385*	70mm	Ford 5.0L EFI	24 lbs./hr.	94103101 (B)	94103301 (B)
385 - 480*	70mm	Ford 5.0L EFI	30 lbs./hr.	94104101 (B)	94104301 (B)
480 - 575*	70mm	Ford 5.0L EFI	36 lbs./hr.	94105201 (B)	94105301 (B)
575 - 670*	70mm	Ford 5.0L EFI	42 lbs./hr.	94106201 (B)	94106301 (B)
Forced Induction (up to 14.7 PSI boost)		Chevrolet Small Block V8; early/late cylinder heads			
350 - 450**	1000	square flange	24 lbs./hr.	91003102 (B)	91003302 (B)
450 - 550**	1000	square flange	30 lbs./hr.	91004102 (B)	91004302 (B)
550 - 650**	1000	square flange	36 lbs./hr.	91005202 (B)	91005302 (B)
650 - 750**	1000	square flange	42 lbs./hr.	91006202 (B)	91006302 (B)
750 - 850**	1000	square flange	50 lbs./hr.	91007202 (B)	91007302 (B)
Forced Induction (up to 14.7 PSI boost)		Chevrolet Small Block V8; Vortec cylinder heads			
350 - 450**	1000	square flange	24 lbs./hr.	91103102 (B)	91103302 (B)
450 - 550**	1000	square flange	30 lbs./hr.	91104102 (B)	91104302 (B)
550 - 650**	1000	square flange	36 lbs./hr.	91105202 (B)	91105302 (B)
650 - 750**	1000	square flange	42 lbs./hr.	91106202 (B)	91106302 (B)
750 - 850**	1000	square flange	50 lbs./hr.	91107202 (B)	91107302 (B)

(*) A brake specific fuel consumption (BSFC) of .45 and 90% duty cycle is used for the maximum horsepower recommendation.

(**) A brake specific fuel consumption (BSFC) of .6 and 90% duty cycle is used for the maximum horsepower recommendation.

NOTE: Downloadable base fuel maps are available at www.holley.com.

(A) Not legal for street use in California on vehicles originally equipped with 2-barrel carburetors for which there was no 4-barrel option.

(B) Not legal for sale or use in California on any pollution controlled motor vehicles.











































See page 2 for symbol explanation.

108

www.holley.com



COMMANDER 950™ MULTI-POINT FUEL INJECTION SYSTEMS

HP RANGE	CFM	Throttle Body FLANGE	INJECTOR SIZE	SYSTEM PART NUMBER	
				In-Line Fuel Pump	In-Tank Fuel Pump
Forced Induction (up to 14.7 PSI boost)		Chevrolet Big Block V8; Std. Deck; Oval Port cylinder heads			
290 - 360**	1000	square flange	30 lbs./hr.	92004102 (B) 	92004302 (B) 
360 - 435**	1000	square flange	36 lbs./hr.	92005202 (B) 	92005302 (B) 
435 - 500**	1000	square flange	42 lbs./hr.	92006202 (B) 	92006302 (B) 
500 - 600**	1000	square flange	50 lbs./hr.	92007202 (B) 	92007302 (B) 
Forced Induction (up to 14.7 PSI boost)		Chevrolet Big Block V8; Std. Deck; Rectangular Port Heads			
290 - 360**	1000	square flange	30 lbs./hr.	92104102 (B) 	92104302 (B) 
360 - 435**	1000	square flange	36 lbs./hr.	92105202 (B) 	92105302 (B) 
435 - 500**	1000	square flange	42 lbs./hr.	92106202 (B) 	92106302 (B) 
500 - 600**	1000	square flange	50 lbs./hr.	92107202 (B) 	92107302 (B) 
435 - 500**	2000	Dominator flange	42 lbs./hr.	92306202 (B) 	92306302 (B) 
500 - 600**	2000	Dominator flange	50 lbs./hr.	92307202 (B) 	92307302 (B) 
Forced Induction (up to 14.7 PSI boost)		Chevrolet Big Block V8; Tall Deck; Rectangular Port Heads			
290 - 360**	1000	square flange	30 lbs./hr.	92204102 (B) 	92204302 (B) 
360 - 435**	1000	square flange	36 lbs./hr.	92205202 (B) 	92205302 (B) 
435 - 500**	1000	square flange	42 lbs./hr.	92206202 (B) 	92206302 (B) 
500 - 600**	1000	square flange	50 lbs./hr.	92207202 (B) 	92207302 (B) 
435 - 500**	2000	Dominator flange	42 lbs./hr.	92406202 (B) 	92406302 (B) 
500 - 600**	2000	Dominator flange	50 lbs./hr.	92407202 (B) 	92407302 (B) 
Forced Induction (up to 14.7 PSI boost)		Ford 5.0L V8			
200 - 290**	65mm	Ford 5.0L EFI	24 lbs./hr.	94003102 (B) 	94003302 (B) 
200 - 290**	70mm	Ford 5.0L EFI	24 lbs./hr.	94103102 (B) 	94103302 (B) 
290 - 360**	70mm	Ford 5.0L EFI	30 lbs./hr.	94104102 (B) 	94104302 (B) 
360 - 435**	70mm	Ford 5.0L EFI	36 lbs./hr.	94105202 (B) 	94105302 (B) 
435 - 500**	70mm	Ford 5.0L EFI	42 lbs./hr.	94106202 (B) 	94106302 (B) 

(**) A brake specific fuel consumption (BSFC) of .6 and 90% duty cycle is used for the maximum horsepower recommendation.

NOTE: Downloadable base fuel maps are available at www.holley.com.

(A) Not legal for street use in California on vehicles originally equipped with 2-barrel carburetors for which there was no 4-barrel option.

(B) Not legal for sale or use in California on any pollution controlled motor vehicles.

  or  See page 2 for symbol explanation.

- CARBURETORS
- FUEL INJECTION**
- THROTTLE BODIES
- FUEL PUMPS
- INTAKE MANIFOLDS
- SPRINGS
- CYLINDER HEADS
- SYMBAK
- WATER PUMPS
- BRESSUP
- BATTERY
- STREET & TRUCK ADAPTERS
- POINT-TO-SCALE
- INDEX/ALPHABETIC

Tech Line: 270-781-9741

109

Fuel Injection

MULTI-POINT FUEL INJECTION POWER PACK KITS

New Holley MPI Power Packs are partially assembled and come without an ECU, wiring harness and fuel pump. They are intended for the person who may want to use, or already has, different components. These Power Pack kits can be used with other aftermarket speed-density-type ECUs that are designed for use on a multi-point system.

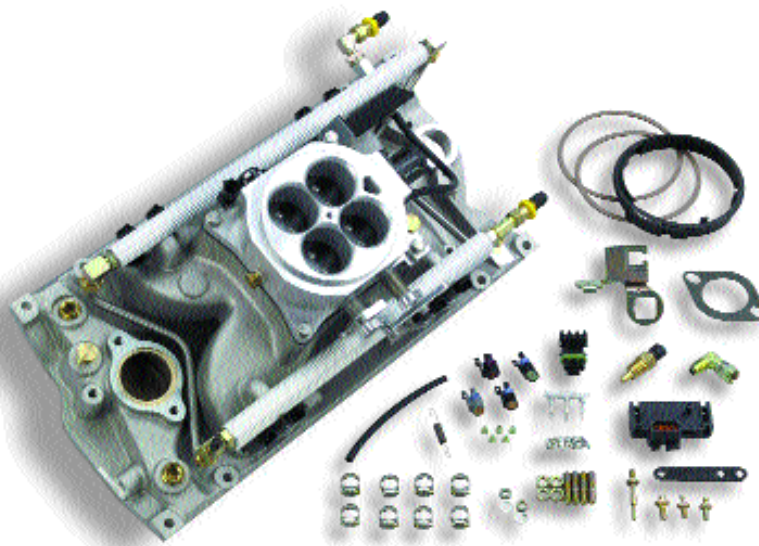

Features

- Power Packs are complete multi-point systems except for ECU, wiring harness and fuel pump
- Fits Chevrolet small block 23° standard port (early and late) & Vortec cylinder heads
- Fits Chevrolet big block oval and rectangular port V8s, including tall decks
- Will work on engines with up to 1520 horsepower
- Includes billet throttle body with progressive linkage
- Includes high fuel flow capacity fuel rails and sensors
- Realize increased torque and horsepower
- Enjoy vastly improved throttle response and idle control

HORSEPOWER RANGE	CFM	Throttle Body FLANGE	INJECTOR SIZE	PART NUMBER
Naturally Aspirated Applications: Chevrolet Small Block V8; Early/Late Cylinder Heads				
225 - 300*	1000	square flange	19 lbs./hr.	81002001 (B)
300 - 385*	1000	square flange	24 lbs./hr.	81003001 (B)
385 - 480*	1000	square flange	30 lbs./hr.	81004001 (B)
480 - 575*	1000	square flange	36 lbs./hr.	81005001 (B)
575 - 670*	1000	square flange	42 lbs./hr.	81006001 (B)
670 - 800*	1000	square flange	50 lbs./hr.	81007001 (B)
800 - 880*	1000	square flange	55 lbs./hr.	81008001 (B)
880 - 1050*	1000	square flange	65 lbs./hr.	81009001 (B)

(*) A brake specific fuel consumption (BSFC) of .45 and 90% duty cycle is used for the maximum horsepower recommendation.

NOTE: Downloadable base fuel maps are available at www.holley.com.

(A) Not legal for street use in California on vehicles originally equipped with 2-barrel carburetors for which there was no 4-barrel option.

(B) Not legal for sale or use in California on any pollution controlled motor vehicles.

or See page 2 for symbol explanation.



MULTI-POINT FUEL INJECTION POWER PACK KITS

HORSEPOWER RANGE	CFM	Throttle Body FLANGE	INJECTOR SIZE	PART NUMBER
Naturally Aspirated Applications: Chevrolet Small Block V8; Vortec Cylinder Heads				
225 - 300*	1000	square flange	19 lbs./hr.	81102001 (B)
300 - 385*	1000	square flange	24 lbs./hr.	81103001 (B)
385 - 480*	1000	square flange	30 lbs./hr.	81104001 (B)
480 - 575*	1000	square flange	36 lbs./hr.	81105001 (B)
575 - 670*	1000	square flange	42 lbs./hr.	81106001 (B)
670 - 800*	1000	square flange	50 lbs./hr.	81107001 (B)
800 - 880*	1000	square flange	55 lbs./hr.	81108001 (B)
880 - 1050*	1000	square flange	65 lbs./hr.	81109001 (B)
Naturally Aspirated Applications: Chevrolet Big Block V8; Std. Deck; Oval Port Heads				
300 - 385*	1000	square flange	24 lbs./hr.	82003001 (B)
385 - 480*	1000	square flange	30 lbs./hr.	82004001 (B)
480 - 575*	1000	square flange	36 lbs./hr.	82005001 (B)
575 - 670*	1000	square flange	42 lbs./hr.	82006001 (B)
670 - 800*	1000	square flange	50 lbs./hr.	82007001 (B)
800 - 880*	1000	square flange	55 lbs./hr.	82008001 (B)
880 - 1050*	1000	square flange	65 lbs./hr.	82009001 (B)
1050 - 1200*	1000	square flange	75 lbs./hr.	82010001 (B)
Naturally Aspirated Applications: Chevrolet Big Block V8; Std. Deck; Rectangular Port Heads				
300 - 385*	1000	square flange	24 lbs./hr.	82103001 (B)
385 - 480*	1000	square flange	30 lbs./hr.	82104001 (B)
480 - 575*	1000	square flange	36 lbs./hr.	82105001 (B)
575 - 670*	1000	square flange	42 lbs./hr.	82106001 (B)
670 - 800*	1000	square flange	50 lbs./hr.	82107001 (B)
800 - 880*	1000	square flange	55 lbs./hr.	82108001 (B)
880 - 1050*	1000	square flange	65 lbs./hr.	82109001 (B)
1050 - 1200*	1000	square flange	75 lbs./hr.	82110001 (B)
575 - 670*	2000	Dominator flange	42 lbs./hr.	82306001 (B)
670 - 800*	2000	Dominator flange	50 lbs./hr.	82307001 (B)
800 - 880*	2000	Dominator flange	55 lbs./hr.	82308001 (B)
880 - 1050*	2000	Dominator flange	65 lbs./hr.	82309001 (B)
1050 - 1200*	2000	Dominator flange	75 lbs./hr.	82310001 (B)
1200 - 1360*	2000	Dominator flange	85 lbs./hr.	82311001 (B)
1360 - 1520*	2000	Dominator flange	95 lbs./hr.	82312001 (B)

(*) A brake specific fuel consumption (BSFC) of .45 and 90% duty cycle is used for the maximum horsepower recommendation.

NOTE: Downloadable base fuel maps are available at www.holley.com.

(A) Not legal for street use in California on vehicles originally equipped with 2-barrel carburetors for which there was no 4-barrel option.

(B) Not legal for sale or use in California on any pollution controlled motor vehicles.

or See page 2 for symbol explanation.

CARBURETORS
FUEL INJECTION
THROTTLE BODIES
FUEL PUMPS
INTAKE MANIFOLDS
SPRINGS
CYLINDER HEADS
SYMBAK
WATER PUMPS
BRESSUP
BATTERY
STREET & TRUCK AIRBLEN
POINT-TO-POINT
INDUSTRY

Tech Line: 270-781-9741

111

Fuel Injection

MULTI-POINT FUEL INJECTION POWER PACK KITS

HORSEPOWER RANGE	CFM	Throttle Body FLANGE	INJECTOR SIZE	PART NUMBER
Naturally Aspirated Applications: Chevrolet Big Block V8; Tall Deck; Rectangular Port Heads				
300 - 385*	1000	square flange	24 lbs./hr.	82203001 (B)
385 - 480*	1000	square flange	30 lbs./hr.	82204001 (B)
480 - 575*	1000	square flange	36 lbs./hr.	82205001 (B)
575 - 670*	1000	square flange	42 lbs./hr.	82206001 (B)
670 - 800*	1000	square flange	50 lbs./hr.	82207001 (B)
800 - 880*	1000	square flange	55 lbs./hr.	82208001 (B)
880 - 1050*	1000	square flange	65 lbs./hr.	82209001 (B)
1050 - 1200*	1000	square flange	75 lbs./hr.	82210001 (B)
575 - 670*	2000	Dominator flange	42 lbs./hr.	82406001 (B)
670 - 800*	2000	Dominator flange	50 lbs./hr.	82407001 (B)
800 - 880*	2000	Dominator flange	55 lbs./hr.	82408001 (B)
880 - 1050*	2000	Dominator flange	65 lbs./hr.	82409001 (B)
1050 - 1200*	2000	Dominator flange	75 lbs./hr.	82410001 (B)
1200 - 1360*	2000	Dominator flange	85 lbs./hr.	82411001 (B)
1360 - 1520*	2000	Dominator flange	95 lbs./hr.	82412001 (B)

Naturally Aspirated Applications: Ford 5.0L V8				
225 - 300*	65mm	Ford 5.0L EFI	19 lbs./hr.	84002001 (B)
300 - 385*	65mm	Ford 5.0L EFI	24 lbs./hr.	84003001 (B)
300 - 385*	70mm	Ford 5.0L EFI	24 lbs./hr.	84103001 (B)
385 - 480*	70mm	Ford 5.0L EFI	30 lbs./hr.	84104001 (B)
480 - 575*	70mm	Ford 5.0L EFI	36 lbs./hr.	84105001 (B)
575 - 670*	70mm	Ford 5.0L EFI	42 lbs./hr.	84106001 (B)
670 - 800*	70mm	Ford 5.0L EFI	50 lbs./hr.	84107001 (B)
800 - 880*	70mm	Ford 5.0L EFI	55 lbs./hr.	84108001 (B)
880 - 1050*	70mm	Ford 5.0L EFI	65 lbs./hr.	84109001 (B)

(* A brake specific fuel consumption (BSFC) of .45 and 90% duty cycle is used for the maximum horsepower recommendation.

NOTE: Downloadable base fuel maps are available at www.holley.com.

(A) Not legal for street use in California on vehicles originally equipped with 2-barrel carburetors for which there was no 4-barrel option.

(B) Not legal for sale or use in California on any pollution controlled motor vehicles.

or See page 2 for symbol explanation.

112

www.holley.com



STEALTH RAM™ MPFI POWER PACK KITS

This kit simplifies the task of converting a factory EFI system to a Stealth Ram. All that's needed is any factory or aftermarket ECU, wiring harness, and fuel pump. It doesn't get much easier... or more powerful.

Each Stealth Ram power pack system includes:

- Stealth Ram upper and lower intake manifold kit
- Holley dual 58mm billet throttle body
- Holley billet fuel rail kit
- Holley fuel injectors
- all EFI sensor required

Part #	STEALTH RAM™ Kit Description	Horsepower Range*
81503001 ^(B)	Satin finish kit with 24 pph injectors	300 - 385
81504001 ^(B)	Satin finish kit with 30 pph injectors	385 - 480
81505001 ^(B)	Satin finish kit with 36 pph injectors	480 - 575
81506001 ^(B)	Satin finish kit with 42 pph injectors	575 - 670
81403001 ^(B)	Polished kit with 24 pph injectors	300 - 385
81404001 ^(B)	Polished kit with 30 pph injectors	385 - 480
81405001 ^(B)	Polished kit with 36 pph injectors	480 - 575
81406001 ^(B)	Polished kit with 42 pph injectors	575 - 670



(*) A brake specific fuel consumption (BSFC) of .45 and 90% duty cycle is used for the maximum horsepower recommendation.

System features:

- Fits early and late^(†) model 23° Chevrolet cylinder heads
- Computer controlled timing available using 1984-1996 GM external coil distributor (billet Holley version available under P/N 890-160).
- Base maps for various combinations to get you started
- Designed to use GM TPI throttle and transmission cables and brackets

(†) Requires angled spacers, P/N 90748

Systems include:

- Upper and lower intake manifolds
- 58mm billet throttle body
- Bright clear anodized aluminum fuel rails
- Fuel injectors
- Fuel pressure regulator
- TPS, MAP, coolant, air temperature and oxygen sensors
- Detailed installation and tuning manuals

Specifications:

- Height is 10-1/4"
- Shipping weight is approximately 45 lbs.



(B) Not legal for sale or use in California on any pollution controlled motor vehicles.

(C) Not legal for street use with a 4-barrel in California on vehicles equipped with a 2-barrel carburetor, for which there was no 4-barrel option.

or See page 2 for symbol explanation.

- CARBURETORS
- FUEL INJECTION**
- THROTTLE BODIES
- FUEL PUMPS
- INTAKE MANIFOLDS
- SPRINGS/SHOCKS
- CYLINDER HEADS
- SYSTEMS
- WATER PUMPS
- BRESS-UP
- BATTERY
- STREET & TRUCK ADAPTERS
- POINT-TO-POINT
- INDEX/ALPHABETIC

Tech Line: 270-781-9741

113

Fuel Injection

COMMANDER 950™ Race Software Upgrade

Part# 950-125 

Want to take the tuning power of your Holley Commander 950 to the "next level"? Here's how: introducing the Commander 950 Race Software upgrade.

A host of new features adds to the already impressive Commander 950 system to make this truly one of the best systems on the market. Included with the software is a detailed tuning manual to help you get the most out of the powerful Commander 950 system. Simply send your ECU back to Holley for some upgrades, and install the new tuning software in your PC.

Features and Benefits

Internal data-logger: Allows user to data-log without a laptop in the vehicle. Will log between 24 seconds and 2.5 minutes depending on sampling rate. Logs up to 13 inputs including two spare 0-5v inputs. Beneficial for sanctioning bodies that do not allow for a lap top to be in a race car or for race application where use of a laptop is difficult; such as a dragster.

Programmable load scale: Allows for the 16 load points to be defined by the user whether speed density or Alpha-N is chosen. Allows for resolution where it is needed. Great feature for supercharged and Alpha-N engines.

Programmable inputs and outputs: Allows some of the inputs and output lines to perform different functions, such as timing retard, a wastegate control, RPM-activated switches, etc.

Programmable O2 voltage: 4 x 4 matrix allows user to program in target closed loop O2 voltage from 0-5 volts depending on RPM and engine load.

Programmable O2 compensation limits: 4x4 matrix with separate (+) and (-) limits allows user to define closed loop compensation limits.

O2 signal inversion: This feature lets you run an aftermarket wideband O2 sensor or a regular narrowband O2 sensor with the Commander 950. Many aftermarket wideband sensors have an output of 0-5 volts from rich to lean and a regular sensor has an output of 0-1 volt from lean to rich.



Wideband O2 operation: The previous three features make it possible to use a wideband O2 sensor and amplifier with the Commander 950 and run closed loop or use it to datalog actual A/F ratio during a run.

Noise block: Allows the magnetic input to be used in noisy environments (such as inside a distributor cap)

RPM to 12750: Allows for peak engine RPM of 12,750 as compared to the standard software of 8,150 RPM.

Deceleration Fuel Cutoff: Shuts fuel off when decelerating for better emissions and fuel economy.

Timing trim vs. Coolant temperature: New table to add timing vs. engine coolant temperature.

Fuel pulse strategy: Allows selection of firing the injectors once per revolution or once every two revolutions. Allows for better idle control with very large injectors.

  or  See page 2 for symbol explanation.

114

www.holley.com



COMMANDER 950™ MPI SERVICE PARTS

Part #

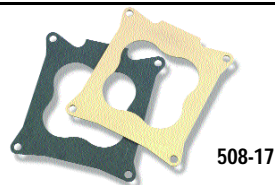

Base Plate & Gasket Sealing Kit

1000 CFM throttle body	508-17
2000 CFM throttle body	508-18

Block-off Plate, IAC

112-560

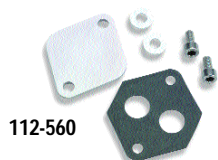

Bracket, MAP Sensor

9902-104



TH-700R4 Transmission Bracket

20-113

Cable, Commander 950

Communication (ECU to laptop)

534-140



ECU- Commander 950

The most advanced fuel management / engine controller available today. See elsewhere for a complete description of features and capabilities of this remarkable unit.

534-120

Filter, Fuel - TBI (metal)

All systems

562-1



Filter Element, Fuel (plastic) Prefilter

562-3

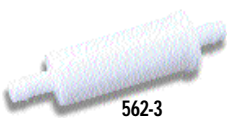

Fittings

Fitting, 90° & Schrader Valve (has 1/8" NPT Tap)	9900-163
Fitting, Regulator	9906-127
Fitting, Swivel #6 to 3/8" Hose Barb	9906-143
Fitting, Swivel 90° Male to SAE 37° #6	9906-118
Fitting, Tee 180° Male to 2x SAE 37° #6	9906-126



CARBURETORS

FUEL
INJECTION

THROTTLE
BODIES

FUEL PUMPS

INTAKE
MANIFOLDS

SPRINGS

CYLINDER
HEADS

SYSTEMS

WATER
PUMPS

BRESS-UP

BATTERY

STREET & TRUCK
AERIALS

POINT-TO-POINT

INDEX/
VARIANTS

Tech Line: 270-781-9741

115

Fuel Injection

COMMANDER 950™ MPI SERVICE PARTS

Part #



Fuel Injectors

See p.136



534-83

Fuel Injector Bungs

PKG./1	534-82
PKG./4	534-83
PKG./6	534-84
PKG./8	534-85



Fuel Injector Connectors and Terminals

6/Pkg. (for Holley top feed injectors)	534-111
8/Pkg. (for Holley top feed injectors)	534-112



534-104

534-102



534-103

Fuel Injector O-Ring and Retainers

Delphi/Holley fuel injector O-ring 16/Pkg.	534-104
Bosch fuel injector retainer 8/Pkg.	534-102
Delphi/Holley fuel injector retainer 8/Pkg.	534-103

Fuel Lines & rails



9900-144

Fuel Line, Fuel Rail Crossover – Small Block Chevrolet V-8
Fits Holley MPI Manifolds **9900-144**



Fuel Line, Fuel Rail Crossover – Big Block Chevrolet V-8
Fits Holley MPI Manifolds **9900-145**



Left & Right Hand Fuel Rails – Small Block Chevrolet V-8
Fits Holley MPI Manifolds **9900-147**



Left & Right Hand Fuel Rails – Big Block Chevrolet V-8
Fits Holley MPI Manifolds **9900-149**



9900-173

Left & Right Hand Fuel Rails, Crossovers, Fittings, Hardware
Small Block Chevrolet V-8 - Fits Holley MPI Manifolds **9900-172**

Left & Right Hand Fuel Rails, Crossovers, Fittings, Hardware
Big Block Chevrolet V-8 - Fits Holley MPI Manifolds **9900-173**

STEALTH RAM™ fuel rail kit w/ non-adjustable regulator **534-185**

STEALTH RAM™ fuel rail kit w/ adjustable regulator **534-186**



108-4

Gasket, air cleaner

108-4



COMMANDER 950™ MPI SERVICE PARTS

Part #



9910-101



9910-102

Gasket, throttle body base

1000 CFM throttle body

9910-101

2000 CFM throttle body

9910-102

Intake Manifolds- Small Block Chevrolet V-8

350 early & late cylinder heads

4bbl square flange design

9901-101-1

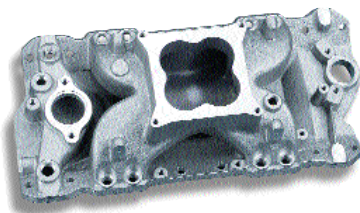

9910-101-1

STEALTH RAM™ design

Satin finish

7540

Polished finish

7540P

350 Vortec/Gen 1 cylinder heads

4 bbl square flange

9901-107

Intake Manifolds- Big Block Chevrolet V-8

Oval port cylinder heads

Standard deck with square flange

9901-209

Rectangular port cylinder heads

Standard deck with square flange

9901-201

Standard deck with DOMINATOR flange

9901-202

Tall deck with square flange

9901-203

Tall deck with DOMINATOR flange

9901-204

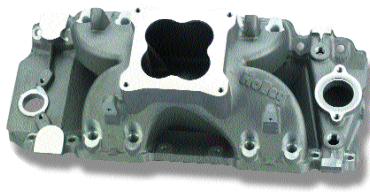

9901-201



12-814

Plate, Fuel Pump Block-Off

Chevrolet – Small Block V8,

Chevrolet – Big Block V8

12-814

CARBURETORS

FUEL
INJECTION

THROTTLE
BODIES

FUEL PUMPS

INTAKE
MANIFOLDS

SPRINGS/SHOCKS

CYLINDER
HEADS

SYSTEMS

WATER
PUMPS

BRESSUP

BATTERY

STREET & TRUCK
AIRBENS

POINT-TO-POINT

INDY/
AMERICAN

Tech Line: 270-781-9741

117

Fuel Injection

COMMANDER 950™ MPI SERVICE PARTS

Part #



12-920

Pump, Fuel Electric

12-920

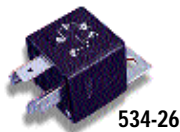

534-26

Relay, 40 Amp.

534-26

Sensors

Air Temp.

9920-107

Coolant Temperature

534-10

Sensor, MAP

Naturally-aspirated motors - (1 bar)

538-24

Forced induction- up to 14.7 PSI boost - (2 bar)

538-13

Forced induction- 14.7 to 29.4 PSI boost - (3 bar)

538-23

Sensor, oxygen

Oxygen sensor

43-106

Sensor bung

534-49



43-106



534-49



9920-104

Sensor, Throttle Position

1000 CFM throttle body

9920-104

2000 CFM throttle body

9920-110

Software

Commander 950 ECU (Mapping & Set-up)

534-144

Pro-Jection MPFI w/ E-PROM

534-117

Pro-Jection (version 3.38)

534-74

Pro-Jection TBI w/ E-PROM

534-77

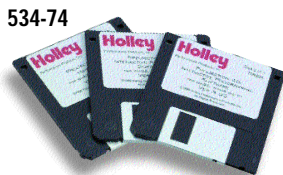

534-74

Throttle Body Assemblies

Universal 1000 CFM w/ IAC

9900-171

Universal 2000 CFM

112-538

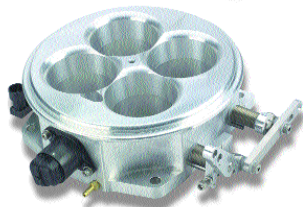

112-538

118

www.holley.com



COMMANDER 950™ MPI SERVICE PARTS

Part #

534-129

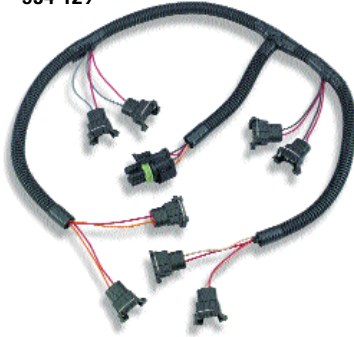

Commander 950 ECU Primary Wiring Harness

ECU-to-sensors (Holley MPI systems)

534-142

Commander 950 ECU Injector Wiring Harness

Holley MPI system (over fuel rail routing)

534-129

Holley MPI system (under intake plenum routing)

534-130

534-138



Commander 950 ECU Accessory Wiring Harness

Cooling fan relay

534-134

Crank trigger w/ magnetic pick up

534-135

Knock sensor

534-136

Chevrolet HEI distributor

534-138

Ford TFI distributor

534-139



CARBURETORS

FUEL
INJECTION

THROTTLE
BODIES

FUEL PUMPS

INTAKE
MANIFOLDS

SPRINKLERS

CYLINDER
HEADS

SYSTEMS

WATER
PUMPS

BRESS-UP

BATTERY

STREET & TRUCK
ALIGNER

POINT-TO-SCALE

INDEX/
VARIANTS

Tech Line: 270-781-9741

119

Fuel Injection

Holley Throttle Body Fuel Injection Systems

General Information



Holley offers one barrel, two barrel and four barrel universal stand-alone throttle body injection systems that will replace a carburetor on a non-computerized vehicle.

One barrel and two barrel systems are available with either the Holley digital "D" ECU or the new Commander 950 ECU. The "D" ECU does not have the ability to be programmed or mapped with a customized fuel map via lap top computer. Rather it uses a basic, pre-programmed performance fuel curve that has a wide range of adjustability. It is intended primarily for stock or very mildly modified vehicles with V8 engines that can maintain at least 15" vacuum at idle (A/T idling in gear). The Commander 950 ECU is a highly

versatile and sophisticated ECU design that enables the user to program a customized fuel map for the motor, through use of a lap top computer.

Two barrel throttle body systems equipped with Commander - 950 can work on any 4 cylinder, even fire 6 cylinder or V8 engines rated not more than 275 horsepower. Special design Holley small block Chevrolet V8 manifolds are also available to accept the two barrel throttle body bolt pattern which is the same as the GM throttle body. Two barrel manifold adapter kits are available for those who wish to retain their stock two barrel intake manifold. Experience, however, has shown that the best performance results are obtained using a aftermarket dual plane intake manifold.

Four barrel systems are available only with the Commander 950 ECU. The Commander 950 ECU can program a multitude of engine parameters with the use of Windows-based software and a lap top computer. A complete explanation of the 950 Commander ECU is contained elsewhere in this section.

Holley four barrel throttle bodies utilize a square flange and are available in four sizes:

- 650 CFM for engines rated 150 - 325 horsepower
- 700 CFM for engines rated 250 - 440 horsepower
- 900 CFM for engines rated 375 - 525 horsepower
- 900 CFM for engines rated 450 - 600 horsepower



Pro-Jection 2D Electronics



Pro-Jection "D" electronics contain a basic performance fuel curve that has a wide range of adjustability. "D" electronics monitor engine RPM and processes a stream of information inputs from the throttle position and engine temperature sensors. From these inputs the "D" system automatically changes, adjusts and modifies the fuel delivery to maintain the fuel curve. Further refinement of the fuel curve is possible by adjusting the knobs on the ECU. The payoff for all this electronic capability is excellent start up, driveability, power and economy. "D" Pro-Jection is designed to be used on stock, or mildly modified engines with at least 15" vacuum at idle (A/T idling in gear).

Commander 950™ Electronics



The awesome power and capability of the Holley Commander 950 ECU is available with any of the Holley throttle body fuel injection systems. The advantages of the 950 are especially obvious for those who need or want a customized fuel curve. Such capability would be desirable when installing a fuel injection system on a modified motor. Stock fuel curves, in such instances, may not have enough functional variability to accommodate the fuel requirements of such an engine over its operational range. The Commander 950 ECU, however, has all the power and capability needed to accomplish this task. The software included with each Commander 950 enables the user to view the fuel map on his laptop computer and modify it, accordingly. Pre-set, downloadable, base fuel maps are available at www.holley.com. A true, custom fuel map is required for the ultimate in performance and driveability. Features and benefits of the Commander 950 have been detailed earlier in this section.

CARBURETORS
FUEL INJECTION
THROTTLE BODIES
FUEL PUMPS
INTAKE MANIFOLDS
SPRINGS
CYLINDER HEADS
SYSTEMS
WATER PUMPS
DRAG-UP
BATTERY
STREET & TRUCK ADAPTER
POINT-TO-POINT
INDEX/ALPHABETIC

Tech Line: 270-781-9741

Fuel Injection

Commander 950™ 4-bbl Throttle Body Fuel Injection Systems



Holley offers a complete line of 4 bbl Commander 950 TBI systems for engines from 150 to 600 horsepower*.

Throttle body fuel injection offers all of the benefits of electronic fuel injection in an easy to install and cost effective package. The Commander 950 provides complete laptop programmability of all fuel and ignition timing parameters.

The throttle body utilizes a progressive linkage for optimum off-idle driveability. The throttle body includes an adjustable regulator and high quality fuel injectors to guarantee years of trouble-free service.

Systems include most components needed for installation including ECU, wiring harness, software, throttle body, fuel pump and filters, sensors, and other misc. components.

NOTE: These systems are designed only for fuel and spark management. Features such as cruise control, transmission control, air conditioning, ABS, etc., are not controlled by the Commander 950.

Features

- Commander 950 ECU
- Complete stand-alone, speed-density systems
- Square flange throttle body
- Die cast aluminum throttle body has a tumble-polished finish
- Allows infinite adjustment of the fuel map via your IBM-compatible PC
- Programmable spark curve (see system requirement)
- MAP, coolant and air temp. sensors
- Oxygen sensor
- Idle air control valve
- 45 PPH injectors used with 650 CFM throttle body
- 65 PPH injectors used with 700 CFM throttle body
- 75 PPH injectors used with 900 CFM throttle body
- 85 PPH injectors used with 900 CFM throttle body
- Self-priming, in-line electric gerotor fuel pump
- 5" airhorn facilitates use of performance carburetor air cleaner assembly
- Designed for bolt on, plug-in installation
- Installed height of throttle body is no greater than a carburetor
- Detailed installation/instruction booklet is included

Benefits

- Fantastic driveability
- Unbelievable throttle response
- Increased power
- Improved engine efficiency
- Great looks

(B) Not legal for sale or use in California on any pollution controlled motor vehicles.

1 2 or 4 See page 2 for symbol explanation.

122

www.holley.com



Commander 950™ 4-bbl Throttle Body Fuel Injection Systems



Description	CFM	Part#
4 cyl., even fire 6 cyl., V8 engine rated 150-325 horsepower*	650	950-23S (B)
4 cyl., even fire 6 cyl., V8 engine rated 250-440 horsepower*	700	950-22S (B)
4 cyl., even fire 6 cyl., V8 engine rated 375-525 horsepower*	900	950-24S (B)
4 cyl., even fire 6 cyl., V8 engine rated 450-600 horsepower*	900	950-21S (B)

(*) A brake specific fuel consumption (BSFC) of .5 and 90% duty cycle is used for the maximum horsepower recommendation.

System Requirements

- Four barrel (square flange) intake manifold (see Intake manifolds in this catalog)
- IBM-compatible personal laptop computer with WIN 3.1, 95, 98, NT, 2000ME, XP software
- The programmable timing feature of this system is available either by:

1. Using one of the following distributors: 1980-1/2 through 1990 GM 7-pin (coil-in-cap); 1984-96 GM (external coil); 1984 - later Ford 7-wire TFI. Use wiring harness adapter **P/N 534-47** for GM distributors and **P/N 534-48** for the Ford distributor.
2. Using a magnetic or Hall Effect crank trigger system when used in conjunction with a after market CD ignition system such as the **Holley Ignition, P/N 800-50, 800-75, 800-100.**

Available Separately

- GM TH-700R4 transmission cable bracket **Part # 20-98**
- Holley 4-bbl intake manifold (see Intake manifolds in this catalog)
- Dual tank installation kit for light duty trucks and motor homes, **Part # 534-38**
- Performance air cleaner (a selection of Holley air cleaners is listed elsewhere in this catalog)

CARBURETORS

FUEL INJECTION

THROTTLE BODIES

FUEL PUMPS

INTAKE MANIFOLDS

SPRINKLERS

CYLINDER HEADS

SYMBAK

WATER PUMPS

BRESS-UP

BATTERY

STREET & TRUCK AIRFILTER

POINT-OF-SALE

INDEX/ALPHABETIC

Tech Line: 270-781-9741

123

Fuel Injection

Commander 950™ 2-bbl Throttle Body Fuel Injection Systems





Commander 950 two barrel throttle body fuel injection systems offer the owners with smaller engines the same opportunity of precise fuel and ignition timing control that others enjoy. Any 4, 6, or 8 cylinder even fire engine can be retrofitted with these systems. Two systems are available, a 670 CFM unit with two 85 lb/hr injectors for engines up to 275 horsepower and a 400 CFM unit with two 65 lb/hr injectors for engines up to 225 horsepower. Both units have an adjustable regulator.

These systems offer all the same features as all other Commander 950 systems such as idle air control motors, closed loop control, speed density operation, ignition timing control, and full laptop programmability.

Adapters are included for both square and spread bore intake manifolds. Other applications will require adapters.

NOTE: These systems are designed only for fuel and spark management. Features such as cruise control, transmission control, air conditioning, ABS, etc., are not controlled by the Commander 950.

Description	CFM	Part#
4 cyl., even fire 6 cyl., V8 engine rated not more than 225 horsepower*	400	950-19S (B) 
4 cyl., even fire 6 cyl., V8 engine rated not more than 275 horsepower*	670	950-20S (B) 



Available Separately

- GM TH-700R4 transmission cable bracket
Part # **20-96** (factory 4-bbl intake manifold)
Part # **20-97** (aftermarket performance 4-bbl intake manifold)
- Holley 2-bbl throttle body intake manifold adapters
Part # **17-46** (Rochester 2-bbl flange)
Part # **17-47** (Holley 2300/Motorcraft 2-bbl flange)
- Holley 2-bbl throttle body small block Chevrolet aluminum intake manifolds Part # **300-49** (1957-86 all and 1987-later with aluminum cylinder heads) Part # **300-66** (1987-later with cast iron cylinder heads)
- Dual tank installation kit for light-duty trucks
Part # **534-37**

System Requirements

- 4 cylinder, Even Fire 6 cylinder or V8
400 CFM: not more than 225 horsepower
670 CFM: not more than 275 horsepower
- IBM-compatible personal laptop computer with WIN 3.1, 95, 98, NT, 2000ME, and XP software
- The programmable timing feature of this system is available either by:
 1. Using one of the following distributors: 1980-1/2 through 1990 GM 7-pin (coil-in-cap); 1984-96 GM (external coil); 1984 - later Ford 7-wire TFI. Use wiring harness adapter **P/N 534-47** for GM distributors and **P/N 534-48** for the Ford distributor.
 2. Using a magnetic or Hall Effect crank trigger system when used in conjunction with a aftermarket CD ignition system such as the Holley Ignition, **P/N 800-50, 800-75, 800-100.**

(B) Not legal for sale or use in California on any pollution controlled motor vehicles.

  or  See page 2 for symbol explanation.



Commander 950™ Auxiliary Injector Driver Kit

Part# 534-122

Looking for something unique? How about 2x4 throttle body fuel injection for a 1,000 horsepower engine, or a 600 horsepower engine? How about a multi-point fuel injection system that's capable of feeding an engine rated up to 1,520 horsepower? Look no further than Holley, the Heart and Soul of Performance to provide the hardware and electronics for your engine-building fantasies. The answer to your dreams is this new Holley Auxiliary Injector Driver Module, P/N 534-122, that can control up to eight (8) low impedance fuel injectors.

This module is designed to work with ECUs (like the Holley Commander 950) that have four (4) "peak to hold drivers". What this module does is expand the ECU's capability to control eight (8) "peak to hold drivers", allowing the use of eight (8) low impedance injectors. With this additional capability, running either a 2x4 throttle body set-up or 8 low impedance injectors in a multi-point system is possible.

Dual 4-bbl TBI units can be used on street or strip engines, either naturally aspirated or supercharged. When dual 4-barrel throttle bodies with progressive throttle linkages are combined with the Commander 950 ECU, the two front injectors of each throttle body can be programmed to activate at low throttle openings. This feature alone can greatly increase around-town driveability and off-idle throttle response. It also eliminates any potential tuning problems with the idle system, as you would have with an injector pulse width that is too low at idle speeds.

With the ability to ance multi-point f can control Holley 65, 75, 85 and 95 pounds per hour I provide enough fu ply an engine rate to 1,520 horsepov

Note: Multi-port installations requir the purchase of tw P/N 534-153 injector wiring harnesses.

Think of the possibilities!

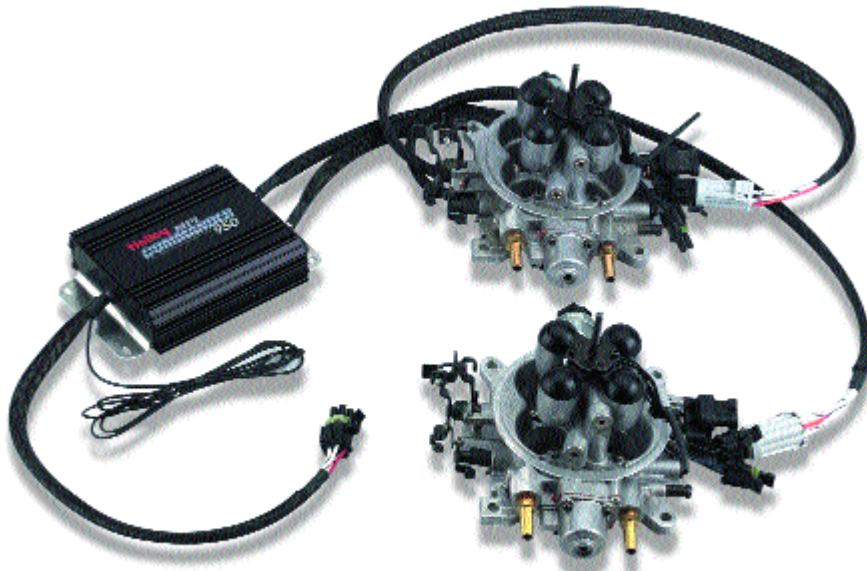

NOTE: Shown is the Auxiliary injector driver kit with two 4-bbl throttle bodies. Throttle bodies **NOT** included with kit.

- CHARGETERS
- FUEL INJECTION**
- THROTTLE BODIES
- FUEL PUMPS
- INTAKE MANIFOLDS
- SPRINKERS
- CYLINDER HEADS
- SYSTEMS
- WATER PUMPS
- DRESS-UP
- BATTERY
- STREET & TRUCK ADAPTERS
- POINT-TO-POINT
- INDEX/ALPHABETIC

Tech Line: 270-781-9741

Fuel Injection

670 CFM Pro-Jection®

Part #

GM, Chrysler, Ford & AMC V-8s

Shiny finish

502-20S^(B) 



Application

- Small block V-8s up to 275 H.P.
- Big block V-8s up to 275 H.P.

Features

- A complete "stand-alone" system.
- Retro-fits only carbureted, non-computerized V-8 engines.
- Die cast aluminum throttle body.
- Dual 85 lb./hour injectors.
- 12 - 22 PSI adjustable pressure regulator.
- Digital ECU is user-adjustable for:
 - Idle
 - Accelerator pump
 - Main
 - High RPM
 - Choke
- Self-priming, in-line electric gerotor fuel pump is rated at 300 lb./hr. @ 15 PSI.
- Wiring harness is designed for "plug-in" installation. It's temperature-insulated and weather-sealed.
- Adjustable fast idle solenoid.
- Installed height of TBI is no greater than standard carburetor.
- Detailed installation instruction booklet is included.



Benefits

- Improved driveability
- Fantastic throttle response
- Greater fuel economy
- Increased power



System Requirements

- Non-computerized V-8 engine of not more than 275 H.P.

Available Separately

- GM TH-700R4 transmission cable bracket
 - P/N: **20-96** (factory 4-bbl. intake manifold)
 - P/N: **20-97** (aftermarket 4-bbl. intake manifold)
- Holley 2-bbl.-manifold-2 bbl.-Pro-Jection adapters
 - P/N: **17-46** (Rochester 2-bbl. flange)
 - P/N: **17-47** (Holley 2300/Motorcraft 2-bbl. flange)
- Holley 2-bbl. Pro-Jection intake manifold for small block Chevrolet V-8s
 - P/N: **300-49** (1957-86 all & 1987-later with aluminum cylinder heads)
 - P/N: **300-66** (1987-later with cast iron cylinder heads)
- Dual tank installation kit for light-duty trucks
 - P/N: **534-37**
- Closed loop kit
 - P/N: **534-54**
- Rich/Lean indicator for vehicles w/o oxygen sensor
 - P/N: **534-50**
- Rich/Lean indicator for vehicles with oxygen sensor
 - P/N: **534-51**

(B) Not legal for sale or use in California on any pollution controlled motor vehicles.

  or  See page 2 for symbol explanation.

126

www.holley.com



300 CFM Pro-Jection®

Part #

1979-82 Jeep 258 CID 2 barrel, manual transmission

Shiny finish **501-12**(B) 3



Application

- 258 CID, M/T, Carter BBD 2 barrel carburetor

Features

- A complete "stand-alone" system
- Polished die cast aluminum throttle body
- New digital ECU software is much improved over old analog system
- Digital ECU is user-adjustable for:
 - Idle
 - Accelerator pump
 - Main system
 - High RPM
 - Choke
- Single 90 pph injector provides for all fuel requirements
- Wiring harnesses are assembled with high quality connectors to provide for "plug-in" installation and protection from the elements
- Fast idle solenoid is included
- Uses factory air cleaner assembly
- Installed height is no taller than stock Carter 2 barrel carburetor
- Closed loop kit (P/N **534-54**) is available for non-air-pump-equipped vehicles to further enhance driveability at all altitudes

Benefits

- Improved driveability
- Fantastic throttle response
- Greater fuel economy
- Increased power
- Eliminate fuel problems due to vehicle angularity

CARBURETORS

FUEL INJECTION

THROTTLE BODIES

FUEL PUMPS

INTAKE MANIFOLDS

SPRINKLERS

CYLINDER HEADS

SYSTEMS

WATER PUMPS

BRESS-UP

BATTERY

STREET & TRUCK AIRRERS

POINT-OF-SALE

NEW/ VARIANTS

(B) Not legal for sale or use in California on any pollution controlled motor vehicles.

1 2 3 See page 2 for symbol explanation.

Tech Line: 270-781-9741

127

Fuel Injection



TBI System Service Parts

	Part #
A. Adapter - Air Cleaner 4-bbl Pro-Jection systems	17-14
B. Adapter - TBI 1-bbl Pro-Jection, P/N 501-2	517-2
C. Adapter - TBI (spread bore to TBI flange) 2-bbl Pro-Jection	17-41
D. Adapter - TBI (square bore to TBI flange) 2-bbl Pro-Jection	17-45
E. Adapter - TBI (square bore to spread bore flange) 2-bbl Pro-Jection	17-6
F. Adapter - TBI (Rochester 2-bbl flange to TBI flange) 2-bbl Pro-Jection	17-46
G. Adapter - TBI (2300 2-bbl flange to TBI flange) 2-bbl Pro-Jection	17-47
H. Bracket - Transmission Cable (GM TH-700R4) 2-bbl Pro-Jection, P/Ns 502-1, 502-2 Chevrolet small block V-8 with original equipment 4-bbl intake manifold	20-96
I. Bracket - Transmission Cable (GM TH-700R4) 2-bbl Pro-Jection, P/Ns 502-1, 502-2 Aftermarket 4-bbl intake manifold	20-97
J. Bracket - Transmission Cable (GM TH-700R4) 4-bbl Pro-Jection, P/Ns 504-1, 504-2	20-98
K. Closed Loop Kit 1-bbl, 2-bbl, 4-bbl Pro-Jection analog systems	534-27
L. Closed Loop Kit 1-bbl & 2-bbl, digital Pro-Jection	534-54
M. Diaphragm, Fuel Pressure Regulator 1-bbl, 2-bbl, 4-bbl Pro-Jection	512-1
N. Distribution Ring, Air	508-10
O. Distribution Ring, Air 4-bbl Pro-Jection systems	508-12

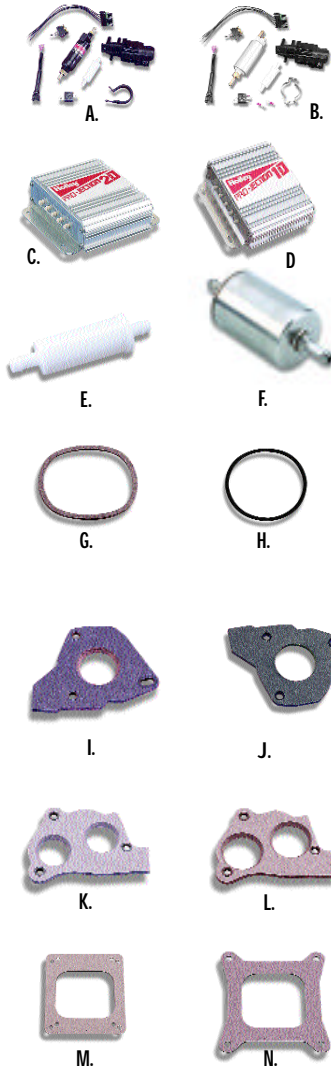

TBI System Service Parts

Part #

A. Dual Tank Fuel Pump Kit 1-bbl Pro-Jection, P/Ns 501-1, 501-2 2-bbl Pro-Jection, P/Ns 502-1, 502-2	534-37
B. Dual Tank Fuel Pump Kit 4-bbl Pro-Jection (All)	534-38
C. Electronic Control Unit (ECU) 1-bbl, 2-bbl Pro-Jection	534-55
D. Electronic Control Unit (ECU) 1-bbl digital Pro-Jection, P/N 501-12	534-72
E. Filter, Fuel - Pump (plastic) All Pro-Jection systems	562-3
F. Filter, Fuel - TBI (metal) All Pro-Jection systems	562-1
G. Gasket, Air Horn 1-bbl replacement TBIs, P/Ns 500-1, 500-2, 500-3, 500-4, 500-5 1-bbl Pro-Jection, P/Ns 501-1, 501-2	508-1
H. Gasket, Air Horn 2-bbl replacement TBIs, P/Ns 502-3, 502-4, 502-5, 502-6, 502-7, 502-8; 2-bbl Pro-Jection, P/Ns 502-1, 502-2; 4-bbl Pro-Jection systems (all)	108-4
I. Gasket, 1-bbl TBI Flange (O.E. manifold/1.68" bore) 1-bbl replacement TBIs, P/Ns 500-1, 500-2, 500-3, 500-4, 500-5	508-2
J. Gasket, 1-bbl TBI Flange (Holley manifold/2.00" bore) 1-bbl replacement TBIs, P/Ns 500-1, 500-2, 500-3, 500-4, 500-5	508-3
K. Gasket, 2-bbl TBI Flange (O.E. manifold/1.68" bores) 2-bbl replacement TBI, P/N 502-3	508-7
L. Gasket, 2-bbl TBI Flange (O.E. manifold/2.00" bores) 2-bbl replacement TBI, P/Ns 502-4, 502-5, 502-6, 502-7, 502-8	508-11
M. Gasket, Flange 2-bbl Pro-Jection, P/N 502-1 Spread bore manifold to either P/Ns 17-41 or 517-1 adapters	508-5
N. Gasket, Flange 2-bbl Pro-Jection, P/N 502-2 Square bore manifold to P/N 17-6 adapter	508-9

CARBURETORS

FUEL
INJECTION

THROTTLE
BODIES

FUEL PUMPS

AIR
MANIFOLDS

SPRINKLERS

CYLINDER
HEADS

SPARK
PLUGS

WATER
PUMPS

DRESS-UP

BATTERY

STREET & TRUCK
ADAPTERS

POINT-OF-SALE

NEW/
VARIABLE

Tech Line: 270-781-9741

129

Fuel Injection

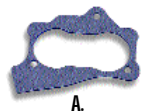

A.

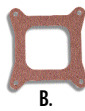

B.



C.

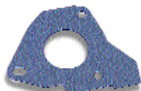

D.



E.



F.



G.



H.



I.



J.



K.



L.



M.

TBI System Service Parts

Part #

A. Gasket, 2-bbl TBI Flange/Adapter 2-bbl Pro-Jection, P/Ns 502-1, 502-2 2 x 2 Pro-Jection, P/N 502-2211 2-bbl TBI flange to either P/Ns 17-41, 17-45 or 517-1 adapters	508-6
B. Gasket, 4-bbl TBI Flange (1/16" thick) All 4-bbl Pro-Jection systems	108-10
C. Gasket, 4-bbl TBI Flange (5/16" thick) All 4-bbl Pro-Jection systems	108-12
D. Gasket, 1-bbl TBI Flange/Adapter 1-bbl Pro-Jection, P/Ns 501-2, 501-12	508-15
E. Gasket, 2-bbl Carter BBD Flange to 1-bbl TBI Adapter 1-bbl Pro-Jection, P/N 501-2	508-16
F. Gasket, 1-bbl TBI Air Cleaner Adapter to O.E. Air Cleaner 1-bbl Pro-Jection, P/Ns 501-1, 501-2	508-14
G. Gasket, Idle Air Control Motor All "D" and "Di" Pro-Jection systems	508-8
H. Idle Air Control Motor 1-bbl and 2-bbl replacement TBIs	543-2
I. Idle Air Control Motor All digital Pro-Jection systems	543-105
J. Injector, Fuel (64 PPH) 1-bbl replacement TBIs, P/Ns 500-1, 500-5	522-2
K. Injector, Fuel - High Flow (69 PPH) 1-bbl replacement TBIs, P/Ns 500-1, 500-2, 500-3, 500-4, 500-5	522-3
L. Injector, Fuel (90 PPH) 1-bbl Pro-Jection, P/Ns 501-1, 501-2	522-40
M. Injector, fuel, performance, Commander 950 systems 32 PPH @ 12 PSI; 45 PPH @ 21 PSI 45 PPH @ 12 PSI; 65 PPH @ 21 PSI 50 PPH @ 12 PSI; 72 PPH @ 21 PSI 60 PPH @ 12 PSI; 85 PPH @ 21 PSI 65 PPH @ 12 PSI; 90 PPH @ 21 PSI	522-81 522-54 522-80 522-43 522-83



TBI System Service Parts

Part #

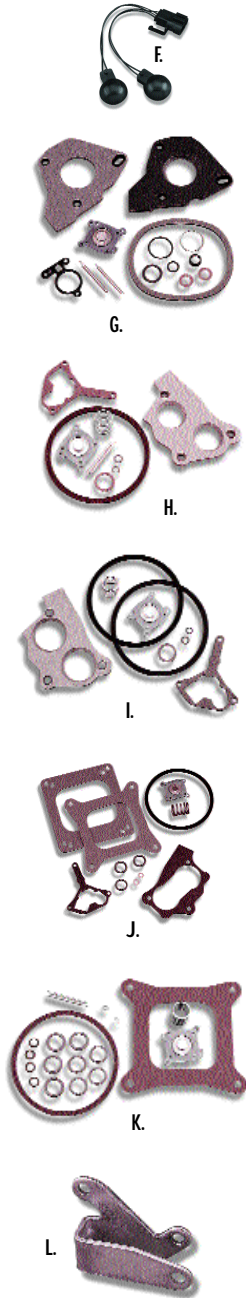

A. Injector, O-ring kit

Commander 950 performance injector
(includes O-rings for four injectors)

534-164

B. Injector, retaining plate with air cleaner stud

2-bbl throttle body, Commander 950 systems
4-bbl throttle body, Commander 950 systems

534-165
534-166

C. Injector, wiring harness, Commander 950 systems

2-bbl throttle body
4-bbl throttle body

534-167
534-168

D. Injector pod, replacement, Commander 950 throttle body

2-bbl throttle body
4-bbl throttle body
(does not include injectors)

534-162
534-163

E. Injector pod upgrade kit for Pro-Jection throttle bodies

2-bbl throttle body
4-bbl throttle body
(upgrades "old-style" throttle body for new performance injectors; includes injector wiring harness and retaining plate)

534-170
534-169

F. Injector Caps, Replacement

2-bbl Pro-Jection

534-100

G. Kit, Renew

1-bbl replacement TBIs
1-bbl Pro-Jection systems

503-1

H. Kit, Renew

2-bbl replacement TBI, P/N 502-3

503-2

I. Kit, Renew

2-bbl replacement TBIs, P/Ns 502-4, 502-5,
502-6, 502-7, 502-8

503-5

J. Kit, Renew

2-bbl Pro-Jection (All)
2 x 2 Pro-Jection

503-3

K. Kit, Renew

4-bbl Pro-Jection (All)

503-6

L. Lever, Throttle Extension (Chrysler)

2-bbl Pro-Jection (All)
2 x 2 Pro-Jection
4-bbl Pro-Jection (All)

20-7

Tech Line: 270-781-9741

131

CARBURETORS

FUEL
INJECTION

THROTTLE
BODIES

FUEL PUMPS

INTAKE
MANIFOLDS

SPRINGBRASS

CYLINDER
HEADS

SYSTEMS

WATER
PUMPS

DRESS-UP

BATTERY

STREET & TRUCK
AIRRISERS

POINT-TO-SCALE

INDEX/
VARIANTS

Fuel Injection

TBI System Service Parts

Part #

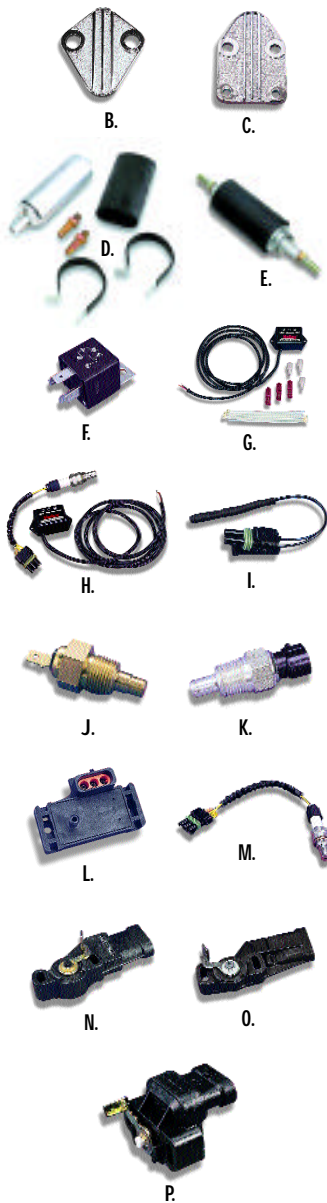

A. Linkage kit, 4-bbl throttle body Progressive secondary action 1:1 secondary action	534-160 534-161
B. Plate, Fuel Pump Block-Off Chrysler - Big Block V-8 Chrysler - Small Block V-8	12-813
C. Plate, Fuel Pump Block-Off Chevrolet - Small Block V-8 Chevrolet - Big Block V-8	12-814
D. Pump, Electric Fuel (258 PPH @ 15 PSI) All 1-bbl Pro-Jection All 2-bbl Pro-Jection	12-927
E. Pump, Electric Fuel All 4-bbl Pro-Jection (480 PPH @ 15 PSI) All MPI systems (402 PPH @ 45 PSI)	12-920
F. Relay, 40 Amp. All Pro-Jection systems	534-26
G. Rich/Lean Indicator w/o Oxygen Sensor	534-50
H. Rich/Lean Indicator w/ Oxygen Sensor	534-51
I. Sensor, Air Charge All digital Pro-Jection systems	534-46
J. Sensor, Coolant Temperature All 4-bbl analog Pro-Jection systems P/N 502-20 digital 2-bbl Pro-Jection	534-2
K. Sensor, Coolant Temperature All 4-bbl digital Pro-Jection systems	534-10
L. Sensor, MAP All digital Pro-Jection systems All Commander 950 systems	538-13 538-24
M. Sensor, Oxygen All digital Pro-Jection systems Closed loop kit, P/N 534-27	43-106
N. Sensor, Throttle Position 1-bbl replacement TBIs, P/Ns 500-1, 500-3, 500-5 1-bbl Pro-Jection, P/Ns 501-1, 501-2	543-1
O. Sensor, Throttle Position 1-bbl replacement TBIs, P/Ns 500-2, 500-4 2-bbl Pro-Jection, P/Ns 502-1, 502-2, 502-20 2 x 2 Pro-Jection, P/N 502-2211	543-3
P. Sensor, Throttle Position 2-bbl replacement TBIs, P/Ns 502-3, 502-4, 502-5, 502-6, 502-7, 502-8 4-bbl Pro-Jection, P/Ns 504-1, 504-2, 504-11, 504-12, 504-13, 504-21, 504-22, 504-23	543-29



TBI System Service Parts

Part #



A.



B.



C.



D.

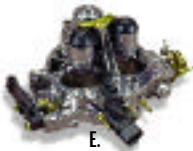

E.



F.



G.



I.

A. Software, Data Acquisition

"D" Pro-Jection Systems

"Di" Pro-Jection Systems

534-71

B. Software, Interactive Mapping (3.5" IBM diskette – Windows 3.x/95 and DOS 6.0) 64 point acceleration compensation map

4-bbl Pro-Jection, P/Ns 504-21, 504-22, 504-23

534-44-1

C. Solenoid, Fast Idle

All 2-bbl and 4-bbl analog Pro-Jection systems

1-bbl and 2-bbl Digital systems

46-74

D. TBI Assembly (300 CFM)

1-bbl Pro-Jection, P/Ns 501-1, 501-2, 501-12

500-14

E. TBI Assembly (670 CFM)

2-bbl Pro-Jection, P/Ns 502-1, 502-2

500-6S

F. TBI Assembly - Primary (670 CFM)

2 x 2 Pro-Jection, P/N 502-2211

500-11

G. TBI Assembly - Secondary (670 CFM)

2 x 2 Pro-Jection, P/N 502-2211

500-12

H. TBI Assembly (900 CFM)

4-bbl Pro-Jection,
P/Ns 504-11, 504-21

500-16S

H. TBI Assembly (700 CFM)

4-bbl Pro-Jection,
P/Ns 504-12, 504-22

500-17S

H. TBI Assembly (650 CFM)

4-bbl Pro-Jection,
P/Ns 504-13, 504-23

500-18S

Throttle body assemblies, Commander 950 systems

400 CFM 2-bbl w/ 65 PPH injectors

534-174

670 CFM 2-bbl w/ 85 PPH injectors

534-175

650 CFM 4-bbl w/ 45 PPH injectors

534-171

700 CFM 4-bbl w/ 65 PPH injectors

534-172

900 CFM 4-bbl w/ 85 PPH injectors

534-173

I. Weld Ring, Oxygen Sensor

Closed loop kit, P/N 534-27

All 4-bbl digital Pro-Jection systems

534-49

COMMANDERS

FIAT
INJECTION

THRITTLE
BODIES

FUEL PUMPS

INTAKE
MANIFOLDS

SPRINGBRASS

CYLINDER
HEADS

SYSTEMS

WATER
PUMPS

BRESSUP

BATTERY

STREET & TRUCK
AIRBERS

POINT-TO-SCALE

INDEX/
VARIANTS

Tech Line: 270-781-9741

133

Fuel Injection

TBI System Service Parts

Part #



A.

A. Wiring Harness

1-bbl Pro-Jection

2-bbl Pro-Jection

534-25-1



B.

B. Wiring Harness

4-bbl Pro-Jection, P/Ns 504-11, 504-12, 504-13,
504-21, 504-22, 504-23

534-43



C.

C. Wiring Harness Adapter

All analog 2-bbl Pro-Jections with old-style ECU with
ribbed/finned housing. Adapter allows connection either
to "newer" analog or "state-of-the-art" digital ECU.

534-23



D.

D. Wiring Harness Adapter

All digital interactive (Di) Pro-Jection systems. Allows
connection to GM distributor for ignition control feature.

534-47

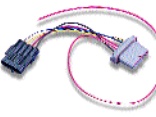

E.

E. Wiring Harness Adapter

All digital interactive (Di) Pro-Jection systems. Allows
connection to Ford distributor for ignition control feature.

534-48



F.

F. Wiring Harness, Closed Loop

Digital 2-bbl Pro-Jection

534-56



G.

G. Wiring Harness - Computer Cable DB-9

All digital interactive (Di) Pro-Jection systems.
Allows computer hookup for tuning purposes.

534-45



H.

H. Wiring Terminals Package

2-bbl Pro-Jection, P/Ns 502-1, 502-2

534-4



EFI FUEL RAILS

These Holley CNC machined aluminum fuel rails are designed to provide a substantial increase in fuel flow over the stock fuel rails. The ability to flow more fuel is especially important when you start building a high performance fuel-injected motor for street or race. Both universal and dedicated application designs are available from Holley for domestic and import applications, in various colors. **Some modification to fuel delivery and return lines may be required for some applications.** Holley EFI fuel rails are the perfect complement to the Holley lines of high flow in-tank fuel pumps, performance fuel injectors, intake manifolds, adjustable fuel pressure regulators and high flow billet throttle bodies.

Application	Comments	P/N	P/N	P/N
		Clear Coat	Red	Blue
Acura Integra	High flow performance replacement for O.E. fuel rail. Use with Keihin injectors.	534-93	534-93-1	534-93-2
Acura Integra	High flow performance replacement for O.E. fuel rail. Use with Holley injectors.	534-94	534-94-1	534-94-2
Chrysler 318/360	High flow performance replacement for O.E. fuel rail.	534-95	534-95-1	534-95-2
Ford 302/351W	High flow performance replacement for O.E. fuel rail	534-98		
Ford 4.6L V-8 (SOHC 1996-98)	High flow performance replacement for O.E. fuel rail	534-92	534-92-1	534-92-2
Ford 5.4L V-8	High flow performance replacement for O.E. fuel rail.	534-121	534-121-1	534-121-2
Honda	High flow performance replacement for O.E. fuel rail	534-86	534-86-1	534-86-2
Honda	High flow performance replacement for O.E. fuel rail. Use with Holley injectors. Can also use with Holley regulator, P/N 512-506."	534-87	534-87-1	534-87-2
Mitsubishi	High flow performance replacement for O.E. fuel rail. Use with Keihin injectors.	534-114	534-114-1	534-114-2
Mitsubishi	High flow performance replacement for O.E. fuel rail. Use with Holley injectors.	534-115	534-115-1	534-115-2
Universal	12" length	534-78	N/A	N/A
Universal	18" length	534-79	N/A	N/A
Universal	36" length	534-80	N/A	N/A

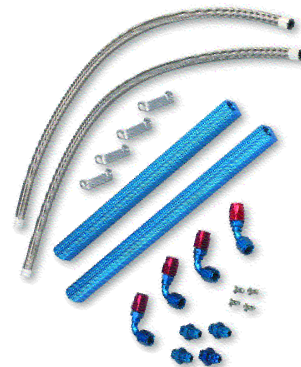

534-92-2

- CARBURETORS
- FUEL INJECTION**
- THROTTLE BODIES
- FUEL PUMPS
- INTAKE MANIFOLDS
- SPRINKLERS
- CYLINDER HEADS
- SYMPOX
- WATER PUMPS
- BRESSUP
- BATTERY
- STREET & TRUCK AERIALS
- POINT-SCALE
- INDEX/ALPHABETIC

Tech Line: 270-781-9741

Fuel Injection

Performance Fuel Injector Kits

These injector kits will enable you to upgrade the fuel delivery system of your engine. This is a definite necessity when you begin modifying a stock engine with such items as a performance fuel pump and camshaft or modifying the stock cylinder heads or upgrading to new performance cylinder heads, adding headers, high-flow throttle bodies, etc.

The fuel injectors here are all top-fed, Bosch-style with various flow ratings as shown below. The chart also equates the injector fuel flow potential to a engine horsepower rating.

Note: To convert lbs. per hour fuel flow to cc per minute fuel flow, multiply the lbs. per hour number by 10.5092. For example, 42 lbs. per hour is equal to 441.3 cc per minute fuel flow.



PART #	APPLICATION/HORSEPOWER*	QTY	INJECTOR FLOW (lbs/hr)	IMPEDANCE
522-1901	Universal 1986-93 Ford 302 and 1985-92 GM	1	19	High
522-1904	305 TPI engines with a maximum	4	19	High
522-1906	of 300 horsepower	6	19	High
522-1908		8	19	High
522-2401	Universal 1985-92 GM 350 TPI and 1992-97 GM	1	24	High
522-2404	LT-1/LT-4 engines with a maximum	4	24	High
522-2406	of 385 horsepower	6	24	High
522-2408		8	24	High
522-3001	Universal Buick GN	1	30	High
522-3004	Universal Buick GN; 240 HP maximum	4	30	High
522-3006	Universal Buick GN; 360 HP maximum	6	30	High
522-3008	Universal Buick GN; 480 HP maximum	8	30	High
522-3601	Universal	1	36	High
522-3604	Universal; 290 HP maximum	4	36	High
522-3606	Universal; 430 HP maximum	6	36	High
522-3608	Universal; 575 HP maximum	8	36	High
522-4201	Universal	1	42	High
522-4204	Universal; 335 HP maximum	4	42	High
522-4206	Universal; 500 HP maximum	6	42	High
522-4208	Universal; 670 HP maximum	8	42	High
522-5001	Universal	1	50	High
522-5004	Universal; 400 HP maximum	4	50	High
522-5006	Universal; 600 HP maximum	6	50	High
522-5008	Universal; 800 HP maximum	8	50	High
522-5501	Universal	1	55	Low
522-5504	Universal; 440 HP maximum	4	55	Low
522-5506	Universal; 660 HP maximum	6	55	Low
522-5508	Universal; 880 HP maximum	8	55	Low
522-6501	Universal	1	65	Low
522-6504	Universal; 525 HP maximum	4	65	Low
522-6506	Universal; 785 HP maximum	6	65	Low
522-6508	Universal; 1050 HP maximum	8	65	Low
522-7501	Universal	1	75	Low
522-7504	Universal; 600 HP maximum	4	75	Low
522-7506	Universal; 900 HP maximum	6	75	Low
522-7508	Universal; 1200 HP maximum	8	75	Low
522-9501	Universal	1	95	Low
522-9504	Universal; 760 HP maximum	4	95	Low
522-9506	Universal; 1140 HP maximum	6	95	Low
522-9508	Universal; 1520 HP maximum	8	95	Low

(*) A BSFC of 0.45 and 90% duty cycle is used for the maximum horsepower recommendation.

THROTTLE BODIES



Section	Page #
Throttle Bodies	
Direct Replacement	138
GM Airfoil Kit	139
Universal 4 Bbl Billet	139
Dedicated 1 and 2 Bbl Billet	140,141
Service Parts and Accessories	142

Throttle Bodies

Direct Replacement Performance TBIs

Holley designed these throttle bodies with all relevant emission provisions and hook-ups for a true 50-State legal installation. They are engineered for a "bolt-on" installation on stock factory manifolds for the applications cataloged. The one barrel throttle bodies have been assigned California Air Resources Board (C.A.R.B.) Executive Order (E.O.) number D-115-4. The two barrel throttle replacement bodies are considered to be the functional equivalent of the original equipment throttle body and, as such, are considered to be 50-State legal. Therefore, the C.A.R.B. E.O. number is not required.

Features

- Direct replacement for O.E. units
- Bolt-on performance replacement for O.E. GM TBI units
- Can increase horsepower up to 25%
- Compatible only with stock O.E. GM electronics
- Provides increased torque and horsepower

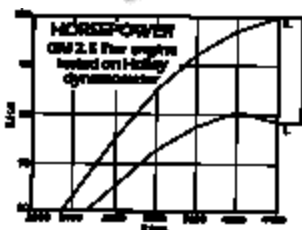

1. **Holley** 2. **Stock**

Holley TBI H.P. Gains

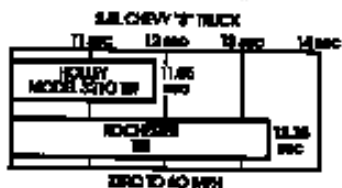

2.8L Zero-60 MPH

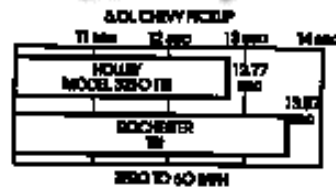

5.0L Zero-60 MPH

Make	Model	Year	Engine	# Bbl	CFM	P/N
Buick	Skylark	1982-86	2.5L 4 cyl.	1	300	500-1
Chevrolet	Celebrity, Citation, Camaro	1982-86	2.5L 4 cyl.	1	300	500-1
Chevrolet	Full size car	1985-90	4.3L 6 cyl.	2	670	502-8
Oldsmobile	Ciera, Omega	1982-86	2.5L 4 cyl.	1	300	500-1
Pontiac	6000 Phoenix	1982-86	2.5L 4 cyl.	1	300	500-1
Chev/GMC	S/T Series Truck	1982-86	2.5L 4 cyl.	1	300	500-1
Chev/GMC	S/T Series Truck	1985 1/2-89	2.8L 6 cyl.	2	400	502-3
Chev/GMC	S/T Series Truck	1988-91	4.3L 6 cyl.	2	670	502-7
Chev/GMC	Full size Truck	1986-89	4.3L 6 cyl.	2	670	502-4
Chev/GMC	Full size Truck	1987-89	5.0L 8 cyl.	2	670	502-5
Chev/GMC	Full size Truck	1987-89	5.7L 8 cyl.	2	670	502-6



AIRFOIL KIT & THROTTLE BODIES

Part #

GM Throttle Body Airfoil Kit

120-140



1985-92 Camaro/Firebird w/ 5.7L TPI

1992-98 Camaro/Firebird w/ 5.7L LT1



120-140

Talk about a smooth operator! This Holley airfoil kit easily adapts to the stock GM throttle body on Chevrolet 5.7L TPI and LT1 engines used on Camaros and Firebirds. It acts to smooth out and minimize the turbulence of the incoming flow of air into the throttle body. The September, 2002 edition of GM HIGH-TECH PERFORMANCE magazine reported a 5.8 horsepower increase after installing this Holley airfoil kit on a stock 1994 Camaro Z28 LT1, called "The Grape Of Wrath".

Installation is easy; simply snap it into place in the mouth of the throttle body and it's ready to work. Made from space age elastomer, the Holley airfoil will perform effectively and unobtrusively for years.

UNIVERSAL 4-BBL BILLET THROTTLE BODIES

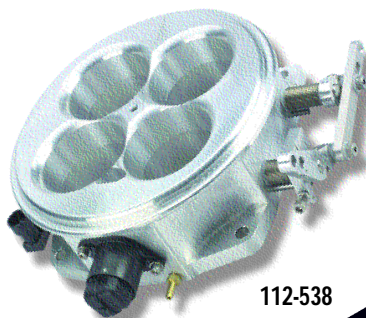

112-538

1000 CFM (square flange) with IAC

9900-171

2000 CFM (DOMINATOR flange)

112-538

If you're thinking of building either a high performance or race multi-point fuel injection system for your engine, look no further than Holley for the throttle body.

Holley offers a line of universal throttle bodies that range in sizes from 1000 CFM to 2000 CFM and are available with standard square bore or DOMINATOR flanges. These billet beauties will provide all the air your

motor can ingest. Sporting precision features that enhance their ruggedness and durability, Holley performance throttle bodies are built to take the most severe usage. They'll look great as well — sitting on top of your street rod or street/strip engine. They have the looks to go with the brawn!

FEATURES:

- True cut CNC billet construction
- Progressive linkage system for more precise throttle control and better driveability.
- Idle air control (IAC) system incorporates over-sized passages to accommodate larger engines to further enhance idle quality and control.
- Throttle shafts are offset with respect to the throttle plates so engine vacuum will assist throttle plate closure.
- Provision for installing Holley P/N 20-113, TH-700R4 over-drive transmission kick-down cable bracket.
- Special machined radii on top and bottom of throttle body promotes maximum airflow and minimizes air turbulence.
- Three manifold vacuum ports are available including one for PCV.
- 1000 CFM throttle body utilizes a standard square bore while the 2000 CFM throttle body is designed with a DOMINATOR flange.
- 1000 CFM utilizes 1.75" bores while the 2000 CFM utilizes 2.25" throttle bores.

CHROMIUMS
FUEL INJECTION
THROTTLE BODIES
FUEL PUMPS
AIR/FUEL MANNIFOLDS
SUPERCHARGERS
CYLINDER HEADS
SYSTEMS
WATER PUMPS
DRESSUPS
BATTERY
STREET & TRUCK AERIALS
PUMP-OUTS
AIR/FUEL MANNIFOLDS

Tech Line: 270-781-9741

139

Throttle Bodies

HOLLEY HIGH-FLOW EFI THROTTLE BODIES

Does your engine seem like it's out of breath? You can increase engine breathing with a Holley high-air-flow throttle body! Fully CNC machined from 6061 billet aluminum, these new Holley throttle bodies are designed to use the stock TPS and IAC to simplify installation. Some throttle bodies are even anodized clear, blue or red for good looks. They also include all the necessary vacuum ports and linkage to facilitate installation. Don't get left in the dust. New Holley high-flow throttle bodies are the ticket to ride.

NOTE: Some manifold machining may be required to correctly port-match the throttle body to the intake.



112-504

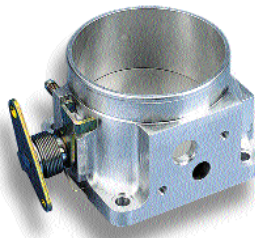

112-512



112-548



112-548-1



112-548-2

Application	Engine	Year	Size	Color	Part #	
Acura Integra	1.8L	1992-95	1 x 62mm	Clear Coat	112-548	2
Acura Integra	1.8L	1992-95	1 x 62mm	Red	112-548-1	2
Acura Integra	1.8L	1992-95	1 x 62mm	Blue	112-548-2	2
Acura Integra	1.8L	1996-00	1 x 62mm	Clear Coat	112-549	2
Acura Integra	1.8L	1996-00	1 x 62mm	Red	112-549-1	2
Acura Integra	1.8L	1996-00	1 x 62mm	Blue	112-549-2	2
Acura Integra	1.8L	1992-95	1 x 68mm	Clear Coat	112-532	2
Acura Integra	1.8L	1992-95	1 x 68mm	Red	112-532-1	2
Acura Integra	1.8L	1992-95	1 x 68mm	Blue	112-532-2*	2
Acura Integra	1.8L	1996-00	1 x 68mm	Clear Coat	112-554*	2
Acura Integra	1.8L	1996-00	1 x 68mm	Red	112-554-1*	2
Acura Integra	1.8L	1996-00	1 x 68mm	Blue	112-554-2*	2
Buick GN/Race	3.8L w/ IAC	1984-87	1 x 95mm	Clear Coat	112-512	2
Buick GN/Race	3.8L w/o IAC	1984-87	1 x 95 mm	Clear Coat	112-513	2
Buick GN/Race	3.8L w/o IAC	1986-93	1 x 105mm	Clear Coat	112-535	2

(B) Not legal for sale or use in California on any pollution controlled motor vehicles.

(C) Not legal for street use with a 4-barrel in California on vehicles equipped with a 2-barrel carburetor, for which there was no 4-barrel option.

2 or 2 See page 2 for symbol explanation.



THROTTLE BODIES cont'd

Application	Engine	Year	Size	Color	Part #	
Chevrolet Camaro	5.7L TPI	1985-88	2 x 52mm	Clear Coat	112-502	2
Chevrolet Camaro	5.7L TPI	1985-88	2 x 58mm	Clear Coat	112-503	2
Chevrolet Camaro	5.7L TPI	1989-92	2 x 52mm	Clear Coat	112-506	2
Chevrolet Camaro	5.7L TPI	1989-92	2 x 58mm	Clear Coat	112-507	2
Chevrolet Camaro	5.7L LT1	1993	2 x 52mm	Clear Coat	112-504	2
Chevrolet Camaro	5.7L LT1	1993	2 x 58mm	Clear Coat	112-505	2
Chevrolet Camaro	5.7L LT1	1994-97	2 x 52mm	Clear Coat	112-508	2
Chevrolet Camaro	5.7L LT1	1994-97	2 x 58mm	Clear Coat	112-509	2
Chevrolet Corvette	5.7L LT1	1992-93	2 x 52mm	Clear Coat	112-504	2
Chevrolet Corvette	5.7L LT1	1992-93	2 x 58mm	Clear Coat	112-505	2
Dodge Truck (all)	3.9L V6	1994-99	2 x 52mm	Clear Coat	112-556	2
Dodge Truck (all)	5.2/5.9L	1994-95	2 x 52mm	Clear Coat	112-555	2
Dodge Truck (all)	5.2/5.9L	1996-01	2 x 52mm	Clear Coat	112-555	2
Ford Mustang	5.0L EFI	1986-93	1 x 65mm	Clear Coat	112-539	2
Ford Mustang	5.0L EFI	1986-93	1 x 70mm	Clear Coat	112-500	2
Ford Mustang	5.0L EFI	1986-93	1 x 75mm	Clear Coat	112-501	2
Ford Mustang	5.0L EFI	1986-93	1 x 80mm	Clear Coat	112-510	2
Ford Mustang	5.0L EFI w/ IAC	1986-93	1 x 95mm	Clear Coat	112-512†	3
Ford Mustang	5.0L EFI w/o IAC	1986-93	1 x 95mm	Clear Coat	112-513†	3
Ford Mustang	5.0L EFI w/o IAC	1986-93	1 x 105mm	Clear Coat	112-535†	3
Honda Civic	1.6L VTEC	1992-95	1 x 62mm	Clear Coat	112-546	2
Honda Civic	1.6L VTEC	1992-95	1 x 62mm	Red	112-546-1	2
Honda Civic	1.6L VTEC	1992-95	1 x 62mm	Blue	112-546-2	2
Honda Civic	1.6L VTEC	1992-95	1 x 68mm	Clear Coat	112-511*	2
Honda Civic	1.6L VTEC	1992-95	1 x 68mm	Red	112-511-1*	2
Honda Civic	1.6L VTEC	1992-95	1 x 68mm	Blue	112-511-2*	2
Honda Civic	1.6L VTEC	1996-00	1 x 62mm	Clear Coat	112-547	2
Honda Civic	1.6L VTEC	1996-00	1 x 68mm	Clear Coat	112-540*	2
Jeep Grand Cherokee	5.9L	1997-98	2 x 52mm	Clear Coat	112-555	2
Pontiac Firebird	5.7L TPI	1985-88	2 x 52mm	Clear Coat	112-502	2
Pontiac Firebird	5.7L TPI	1985-88	2 x 58mm	Clear Coat	112-503	2
Pontiac Firebird	5.7L TPI	1989-92	2 x 52mm	Clear Coat	112-506	2
Pontiac Firebird	5.7L TPI	1989-92	2 x 58mm	Clear Coat	112-507	2
Pontiac Firebird	5.7L LT1	1993	2 x 52mm	Clear Coat	112-504	2
Pontiac Firebird	5.7L LT1	1993	2 x 58mm	Clear Coat	112-505	2
Pontiac Firebird	5.7L LT1	1994-97	2 x 52mm	Clear Coat	112-508	2
Pontiac Firebird	5.7L LT1	1994-97	2 x 58mm	Clear Coat	112-509	2
Universal			1 x 105mm	Clear Coat	112-535†	2

* Intake manifold modifications may be necessary on stock manifolds.

† Uses Ford Mustang style linkage

(B) Not legal for sale or use in California on any pollution controlled motor vehicles.

(C) Not legal for street use with a 4-barrel in California on vehicles equipped with a 2-barrel carburetor, for which there was no 4-barrel option.

1 2 or 3 See page 2 for symbol explanation.

CHROMIUMS
FUEL INJECTION
THROTTLE BODIES
FUEL PUMPS
INTAKE MANIFOLDS
SUPERCHARGERS
CYLINDER HEADS
SYSTEMS
WATER PUMPS
DRESSUP
BATTERY
STREET & TRUCK AIRBLEN
POWER-STEER
HOOD/ AIRBLEN

Tech Line: 270-781-9741

141

Throttle Bodies

THROTTLE BODY SERVICE PARTS

Part #



112-560

Gasket, GM TPI & LT1 throttle body Plate, IAC Block-Off

108-116

Ford throttle bodies

112-560

Spacers, EGR, Ford Throttle Bodies

1-bbl throttle body (1 x 65mm) Clear Coat

112-561 

1-bbl throttle body (1 x 65mm) Red

112-561-1 

1-bbl throttle body (1 x 65mm) Blue

112-561-2 

1-bbl throttle body (1 x 70mm) Clear Coat

112-550 

1-bbl throttle body (1 x 75mm) Clear Coat

112-551 

1-bbl throttle body (1 x 80mm) Clear Coat

112-552 



112-550



112-551

Throttle Plate Service Kits

2000 CFM throttle body

9925-103

1 x 65mm Ford throttle body

26-134

1 x 70mm Ford throttle body (stainless steel plate)

26-130

1 x 75mm Ford throttle body (stainless steel plate)

26-131

1 x 80mm Ford throttle body (stainless steel plate)

26-132





FUEL PUMPS

FUEL PUMPS

Section	Page #
Technical Information	144-149
Mechanical Pumps	150,151
Electric Pumps	
97 GPH	152
110 GPH, 140 GPH.	153
160 GPH, 250 GPH.	154
350 GPH, 500 GPH.	155
Electric In-tank Pumps.	156
Electric In-line Pumps	157
Fuel Pressure Regulators	158-160
Accessories	161
Service Parts	162

Fuel Pumps

Fuel Pumps / Regulator Technical Information



Holley offers a wide selection of both mechanical and electric fuel pumps for a variety of street performance and race applications. Selecting the proper fuel pump for your vehicle, however, begins with understanding your engine's fuel requirements.

Fuel Requirements

Typically, at wide open throttle, full power, an engine requires 0.5 lbs. of fuel per horsepower every hour. A gallon of gasoline weighs approximately 6 lbs. Therefore an engine rated at 350 horsepower will require about 175 pounds (29 gallons) of fuel every hour.

$$\begin{aligned} (350\text{HP} \times .5 \text{ lbs} &= 175 \text{ lbs of fuel} \\ 175 \text{ lbs}/6 \text{ lbs} &= 29 \text{ gallons per hour} \end{aligned}$$



Fuel Pressure and Volume

The relationship of pressure to volume is inversely proportional. That is, as pressure increases the volume will decrease, everything else being equal. A certain amount of fuel pressure is always required to maintain engine performance by assuring that fuel is available on demand. Also, other factors and conditions must be taken into account such as acceleration G-forces and friction within the fuel system itself. At the same time, however, an adequate fuel volume is needed to ensure that the proper amount of fuel can always flow to the engine, especially during peak demand situations. A basic understanding of this critical pressure/volume relationship is needed when designing the proper fuel supply system for your vehicle.

Fuel Line System

The fuel line system should be routed to avoid running near hot spots, such as various exhaust system components, and designed to promote maximum fuel flow. Most factory stock fuel systems utilize 5/16" fuel lines. This size works well on street applications with stock engines. When the horsepower requirements go up, however, the inadequacy of this line size soon becomes apparent. A #6 (3/8") line size is sufficient for all street performance applications and some racing applications. #8 (1/2") fuel lines are used on everything else, including alcohol applications. Avoid using rubber fuel lines, or use them sparingly, for two reasons. First, rubber is more resistant to the flow of fuel than any hard line. An actual pressure loss can be measured over distance. Second, for safety's sake, it's not a good idea to use rubber fuel line, especially when using a high pressure performance fuel pump.

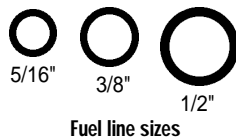

Fuel line sizes

Fuel Line Fittings

Like the fuel line, fuel line fittings are also a very important element in the total fuel line system and should not be overlooked. Obviously, the fittings should be the same size as the fuel line. Also, if at all possible, you want to minimize the use of 90° fittings. Avoid sharp turns or bends in the fuel line routing; these cause undue restrictions to the flow of fuel.





Mechanical Pumps

Various Holley mechanical fuel pumps are available. 110 GPH pumps are designed for street/strip applications where substantially higher than stock fuel delivery requirements are necessary. 3/8" inlet and outlet ports are utilized and, with fuel shut-off pressure in the area of 6-1/2 - 8 PSI, a regulator is not required. 130+ GPH pumps are available when maximum fuel delivery is desirable. 1/2" inlet and outlet ports are included and fuel shut-off pressure is between 7-1/2 - 9 PSI. A pressure regulator is definitely required. Both the 110 GPH and 130+ GPH pumps utilize a high capacity fuel valve design that will ensure an adequate fuel supply is always available.

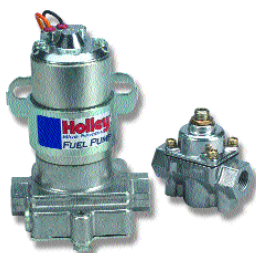

Electric Pumps

Holley offers a complete line of electric in-tank and externally-mounted pumps.

Holley externally-mounted electric fuel pumps are also available in various flow ratings. The "red" pump, P/N 12-801-1, is rated at 97 GPH and it is designed to work with stock or mildly modified engines. Pressure is pre-set to 7 PSI and a regulator is not required. The "blue" pump, P/N 12-802-1, is rated at 110 GPH and it is designed for street/strip applications. Pressure is pre-set at 14 PSI and a regulator is included as part of the package. Neither pump is compatible with methanol or alcohol fuels nor should they be used with fuel injection systems. The "black" pump, P/N 12-815-1, is rated at 140 GPH and is designed to work with either gas or alcohol fuels. This one is similar to the "blue" pump but it kicks out more fuel. These pumps all feature a simple, yet rugged, rotor and vane design which has proved itself over the years.



Two very powerful "VOLUMAX" pumps are available for gasoline or alcohol fuels. They are P/N 12-705-1, rated at 180 GPH and P/N 12-706-1, rated at 275 GPH. These feature a gerotor pump design which is extremely efficient and quiet. Fuel pressure is pre-set at 15 PSI and both a pressure regulator and 3/8" return line to the tank are required. The high volume output of these pumps make them the natural choice for racers who will settle for nothing but the best. **NOTE:** Because of the design of these pumps, it is necessary to connect both fuel pump inlets to the fuel supply for proper operation.

Our electric in-tank line covers coverage for the most popular Ford, Chrysler, GM and Import applications. Utilizing a proven gerotor design, these pumps are available in either a 190 or 255 liter per hour (lph) flow rate.

CHARACTERISTICS

FUEL MEDIUM

THROTTLE BODIES

FUEL PUMPS

IN-TANK MOUNTED

SPECIFICATIONS

CYLINDER HEADS

SYSTEMS

WATER PUMPS

BRESSUP

BATTERY

STREET & TRACK APPLICATIONS

POINT-OF-SALE

NEW/REPLACEMENT

Tech Line: 270-781-9741

145

Fuel Pumps

Fuel Pumps / Regulator Technical Information

Flow Chart for Externally Mounted Electric Fuel Pumps

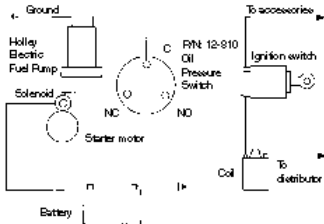
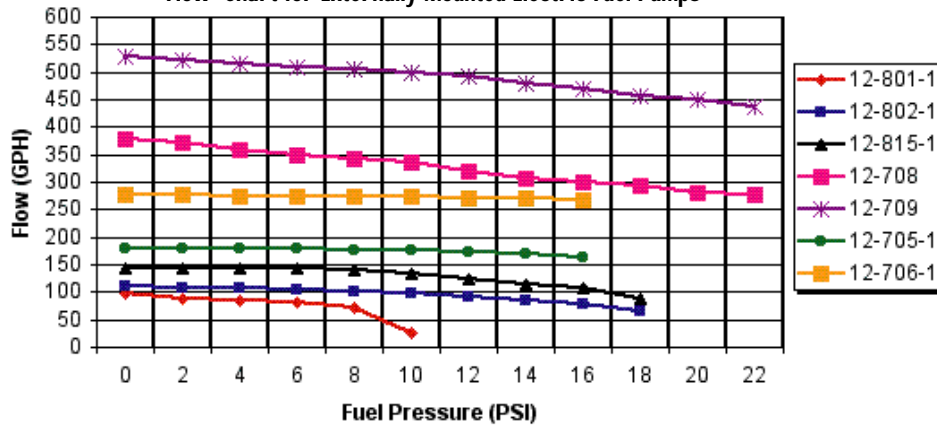

Oil Pressure Safety Switch

It's always a good idea to place a safety switch in the circuit when installing an electric fuel pump. Holley has one available under P/N 12-810. This switch will ensure that the electric pump will not work unless the engine has oil pressure. It will prevent the pump from running in a situation where the motor may stall with the ignition ON. Wiring the switch through the starter solenoid circuit energizes the pump on engine start-up. After the engine is running the switch continues to provide power to the pump as long as there is oil pressure to keep the switch turned on. (SEE ILLUSTRATION)



Fuel Pressure Gauges

There are a number of places where mechanical fuel pressure gauges could be effectively mounted. One place is just before the carburetor. Holley chrome dual feed fuel lines (except model 4500 DOMINATOR) and fuel blocks all have a tapped 1/8 NPT provision for this purpose. Another would be at the outlet side of the pressure regulator. The Holley four-port Pro-Series VOLUMAX regulator incorporates two pressure gauge taps expressly for this purpose. The electric fuel pressure gauge can be mounted inside the vehicle so that fuel pressure can be monitored while driving. This is possible because, unlike the mechanical gauges, fuel does not flow up to the gauge itself. The Holley electric gauge, P/N 26-503, utilizes a remote sending unit which is the primary fuel pressure sensor.



Holley offers a variety of fuel pressure gauges, depending on use. For carbureted vehicles there are two (2) mechanical and one (1) electric gauge available in the 0-15 PSI range.

Vehicles equipped with low pressure (up to 30 PSI) fuel injection systems (like throttle body fuel injection systems) can choose from two mechanical pressure gauges in the 0-30 PSI range.

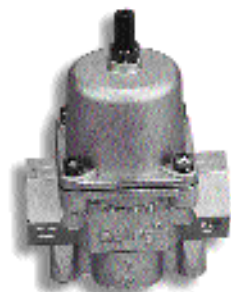

Fuel Filters

What's the use of designing and building a good fuel line system and then choke it down with a restrictive fuel filter? It just doesn't make sense. Therefore, the fuel filter is another important consideration when building and designing your fuel system. A filter that's too small for a particular system is a potential high restriction area that will hinder performance by not allowing the fuel pump to perform to its maximum. Holley offers standard in-line filters that can be used on the street. For the Pro-Series VOLUMAX fuel pumps, Holley recommends using either Holley P/N 162-514 or 162-515 VoluMAX filters.

Fuel Pressure Regulators

The needle and seat assemblies that are installed in Holley performance carburetors can satisfactorily control fuel pressure up to about 8 PSI. If the fuel pump is putting out more than 8 PSI, a regulator should be used to keep the fuel pressure within safe limits and avoid the possibility of flooding. Holley manufactures a number of regulators for most any need. A street regulator is available in either a satin finish (P/N 12-804) or a chrome finish (p/n 12-500). A performance regulator is available in either a satin finish (p/n 12-803) or a chrome finish (p/n 12-501). Both regulators feature a 3/8" NPT inlet port and two 3/8" NPT outlet ports with a .220" restriction (7/32"). The street version regulates pressure from 1 to 4 PSI while the performance version regulates pressure from 4-1/2 to 9 PSI. NOTE: These regulators are designed to work with a single carburetor installation. If two carburetors are used then two regulators will be required, one for each carburetor. Also, two of the P/N 12-803 regulators MUST be used when running a VOLUMAX fuel pump - one for each fuel bowl.

Holley also offers two VOLUMAX regulators. The first, P/N 12-704, is basically a larger version of the two previously mentioned regulators but with more flow capacity. This regulator features a single 1/2" NPT inlet port and two 1/2" outlet ports with a .437" restriction (7/16"). Fuel pressure is regulated from 4-1/2" to 9 PSI. The other regulator, P/N 12-707, is designed for dual carburetor installations. It features four "-6" AN (approximately 3/8") outlet ports and one "-8" AN (approximately 1/2") inlet port with a .437" (7/16") restriction. Three 1/8" NPT fuel pressure gauge ports are also included. Without a doubt these two Pro-Series regulators are the least restrictive, highest flowing, production regulators currently available.

INSTALLATION TIP - for vehicles without fuel return line to the tank: Install the regulator close to the carburetor. Fuel lines from the regulator to the carburetor should be #6 (3/8").

CARBURETORS
FUEL METERING
THROTTLE BODIES
FUEL PUMPS
INLINE MANIFOLDS
SPEEDCHAMBERS
CYLINDER HEADS
SYSTEMS
WATER PUMPS
BRESSUP
BATTERY
STREET & TRACK AIRWORK
POINT-OF-SALE
NEW/UPCOMING

Tech Line: 270-781-9741

Fuel Pumps

Fuel Pumps / Regulator Technical Information

Following are various fuel system schematics for street and race applications. Although intended only as a guide, these designs have been successfully used in many performance applications.

Figure 1 – One (1) #12-802-1 “blue” pump feeding single carburetor, without fuel return line.

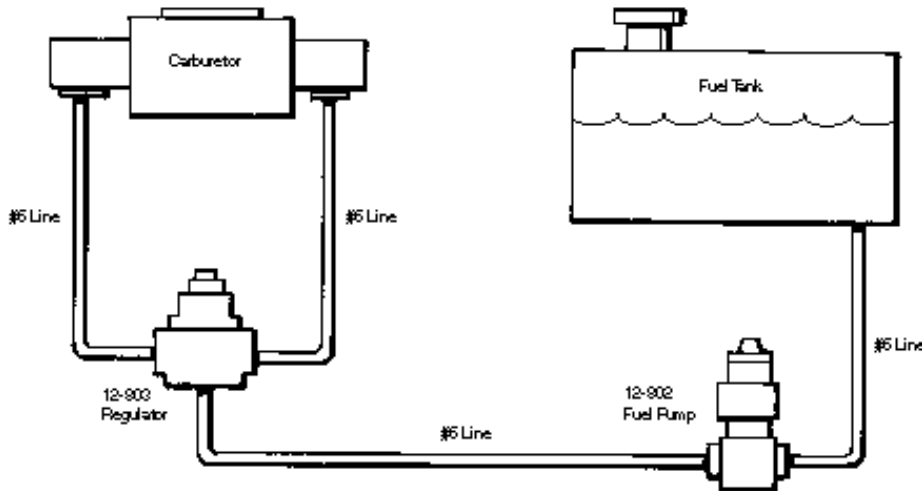

Figure 2 – One (1) #12-706-1 VOLUMAX pump feeding single carburetor.

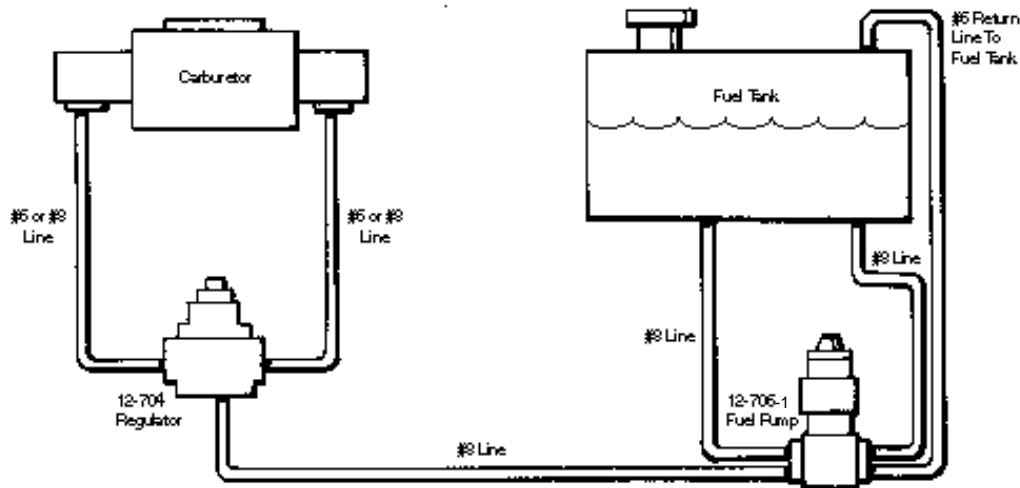



Figure 3 – Two (2) #12-802-1 “blue” pumps feeding single carburetor.

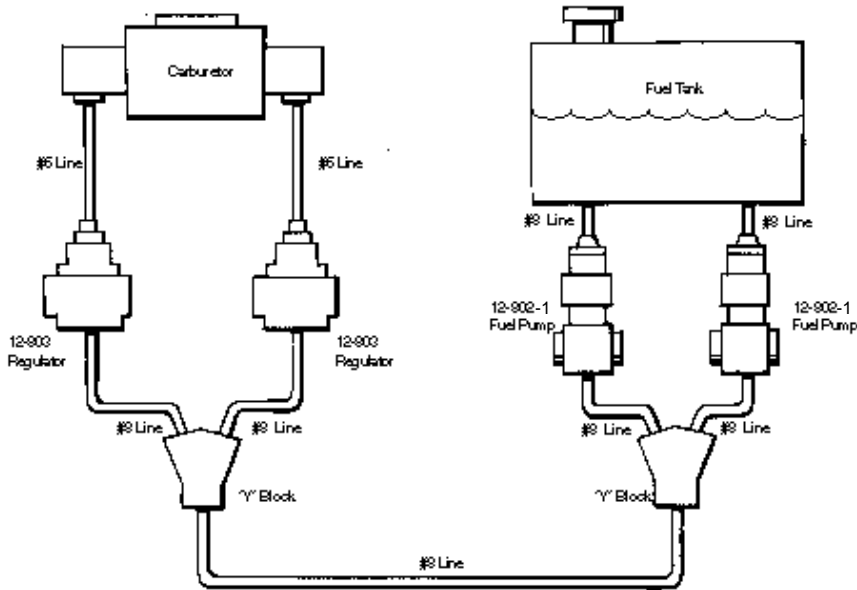
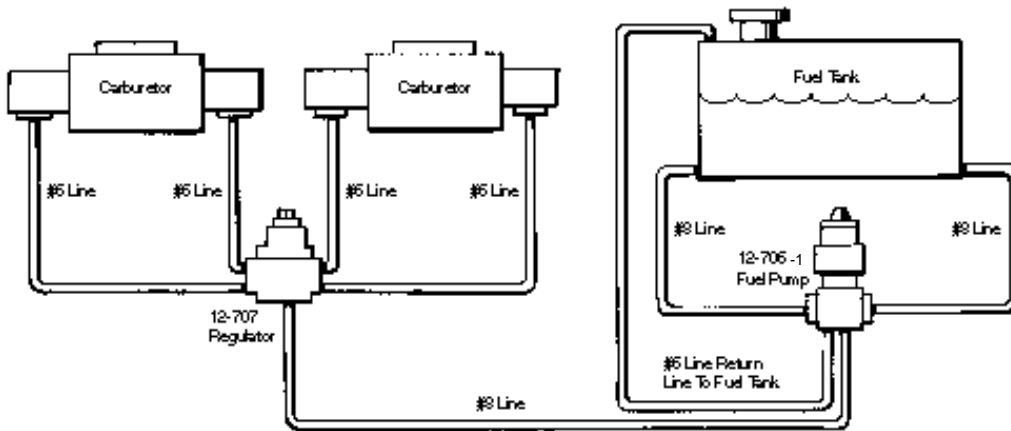

Figure 4 – One (1) #12-706-1 VOLUMAX pump feeding dual carburetors.



CARBURETORS
FUEL METERING
THROTTLE BODIES
FUEL PUMPS
INJECTOR MANIFOLDS
SPEEDCHANGERS
CYLINDER HEADS
SYSTEMS
WATER PUMPS
BRESSUP
BATTERY
STREET & TRACK AIRFLOW
PUMP-UP-SALE
NEW/IMPROVEMENT

Fuel Pumps

MECHANICAL FUEL PUMPS

HOLLEY DESIGNED & BUILT!

Application	80 GPH	110 GPH	130+ GPH	170+ GPH
Chevy S/B V-8	12-834 (B)	12-327-11 (B)	12-327-13 (B)	12-327-20 (B)
Chevy B/B V-8	12-835 (B)	12-454-11 (B)	12-454-13 (B)	NEW! 12-454-20 (B)
Chrysler S/B V-8		NEW! 12-360-11 (B)		
Chrysler B/B V-8		NEW! 12-440-11 (B)		
Ford 289/302/351W	12-833 (B)	12-289-11 (B)	12-289-13 (B)	12-289-20 (B)
Ford 390, 427, 428 FE		NEW! 12-390-11 (B)		
Ford 429/460 V-8	12-860 (B)	12-460-11 (B)	12-460-13 (B)	
Pontiac All V-8		NEW! 12-389-11 (B)		

(*) Inlet and outlet tapped for 1/4" NPT



80 GPH Fuel Pump

Features

- Street Performance
- Flows 80 GPH (free flow)
- Shutoff pressure pre-set at 7-1/2 PSI
- Heavy duty construction for continuous high RPM operation
- Fuel body casting can be rotated to accommodate various plumbing situations
- Fuel pressure regulator is not required
- Inlet & outlet tapped for 3/8" NPT
- Polished aluminum finish

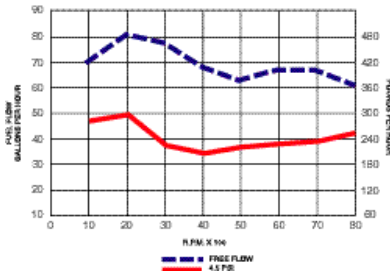

110 GPH Fuel Pump

Features

- High output fuel flow
- Flows 110 GPH (free flow)
- Shutoff pressure pre-set from 6 1/2 - 8 PSI
- Heavy duty construction for continuous high RPM operation
- Fuel body casting can be rotated to accommodate various plumbing situations
- Fuel pressure regulator is not required
- Inlet & outlet tapped for 3/8" NPT, except as noted
- Polished aluminum finish

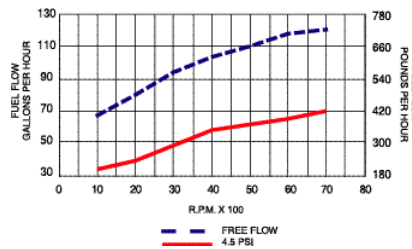

(B) Not legal for sale or use in California on any pollution controlled motor vehicles.

or See page 2 for symbol explanation.

150

www.holley.com



130+ GPH Fuel Pump

Features

- High output fuel flow
- Flows 130+ GPH (free flow)
- Shutoff pressure pre-set from 7 1/2 - 9 PSI
- Heavy duty construction for continuous high RPM operation
- Redesigned high flow valves always ensure adequate fuel delivery
- Inlet & outlet tapped for 3/8" NPT
- Fuel body casting can be rotated to accommodate various plumbing situations
- Fuel pressure regulator is required. Recommend Holley P/N 12-704
- Polished aluminum finish

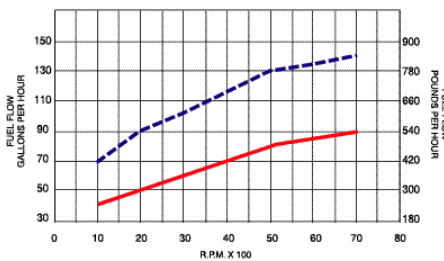

170+ GPH Fuel Pump

Features

- High output fuel flow
- Flows 170+ GPH (free flow)
- Shutoff pressure pre-set at 8 PSI
- Heavy duty construction for continuous high RPM operation
- Redesigned high flow valves always ensure adequate fuel delivery
- AN -10 inlet and -8 outlet ports
- Fuel body casting can be rotated to accommodate various plumbing situations
- Fuel pressure regulator is required. Recommend Holley P/N 12-704
- Polished aluminum finish

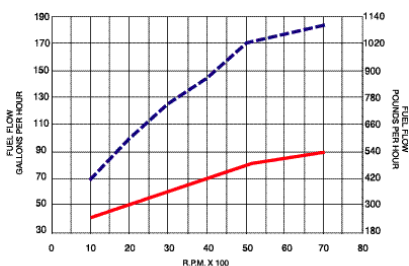

12-389-11



12-360-11

- CARBURETORS
- FUEL METERING
- THROTTLE BODIES
- FUEL PUMPS
- INJECTOR MANIFOLDS
- SPEEDCHANGERS
- CYLINDER HEADS
- SYSTEMS
- WATER PUMPS
- BRESS-UP
- BATTERY
- STREET & TRACK ACCESSORIES
- POINT-OF-SALE
- NEW/IMPROVEMENTS

(B) Not legal for sale or use in California on any pollution controlled motor vehicles.

See page 2 for symbol explanation.

Fuel Pumps

ELECTRIC FUEL PUMPS - CARBURETED

Flow Chart for Externally-Mounted Electric Fuel Pumps

Holley Part#	Free Flow Rate	Flow Rate	Maximum Pressure	Regulator Required
12-801-1	97 GPH	71 GPH @ 4 PSI	7 PSI	No
12-802-1	110 GPH	88 GPH @ 9 PSI	14 PSI	(included)
12-815-1	140 GPH	120 GPH @ 9 PSI	14 PSI	Yes
12-705-1	180 GPH	176 GPH @ 9 PSI	15 PSI	Yes
12-706-1	275 GPH	273 GPH @ 9 PSI	15 PSI	Yes
12-708	375 GPH	294 GPH @ 18 PSI	42 PSI	Yes
12-709	525 GPH	456 GPH @ 18 PSI	58 PSI	Yes

97 GPH "Red" Electric Fuel Pump

Part # **12-801-1**^(B) 



Features

- New tumble polished billet look
- Improved design for street/strip applications
- Distinctive "RED" logo
- Flows 97 GPH (free flow)
- Flows 71 GPH at 4 PSI
- Maximum pressure is 7 PSI
- Regulator is not required
- Motor draws only 2 Amps current
- 7 1/2 Amp fuse recommended
- Provides constant fuel flow with no pulsation
- Has externally accessible pressure relief valve (max 7 PSI)
- Rotor/Vane pump design is more tolerant of contaminated fuels
- New lower housing casting for enhanced fuel flow and quieter operation
- Weighs only 2.88 lbs.
- Includes mounting bracket
- Repair kits are readily available
- Can be serviced from either pump end or brush cap end
- NOT compatible with alcohol or methanol fuels
- Use of safety shut-off switch, **P/N 12-810**, strongly recommended
- Not designed or recommended for use with fuel injection systems

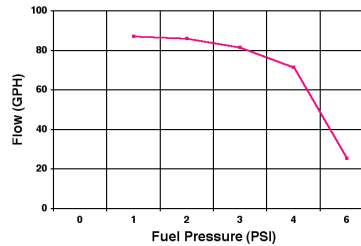

(A) Not legal for street use in California on vehicles originally equipped with 2-barrel carburetors for which there was no 4-barrel option.

(B) Not legal for sale or use in California on any pollution controlled motor vehicles.

 or  See page 2 for symbol explanation.

152

www.holley.com



110 GPH "Blue" Electric Fuel Pump

Part # **12-802-1**^(B)



Features

- New tumble polished billet look
- New lower housing casting for enhanced fuel flow
- Improved design for street/strip applications
- Distinctive "BLUE" logo
 - Flows 110 GPH (free flow)
 - Flows 88 GPH at 9 PSI
 - Maximum pressure is 14 PSI
- Includes **P/N 12-803** fuel pressure regulator
 - Motor draws only 3 Amps current
 - 7 1/2 Amp fuse recommended
 - Provides constant fuel flow with no pulsation
 - Has externally accessible pressure relief valve (max 14 PSI)
 - Rotor/Vane pump design is more tolerant of contaminated fuels
 - Weighs only 3 lbs.
- Includes mounting bracket
- Repair kits are readily available
- Can be serviced from either pump end or brush cap end
- NOT compatible with alcohol or methanol fuels
- Use of safety shut-off switch, **P/N 12-810**, strongly recommended
- Not designed or recommended for use with fuel injection systems

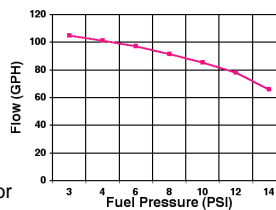

140 GPH "Black" Electric Fuel Pump

Part # **12-815-1**^(B)



Features

- New tumble polished billet look
- New lower housing casting for enhanced fuel flow
- Improved design for street/strip applications
- Distinctive "BLACK" logo
- Compatible with alcohol or methanol fuels
- Flows 140 GPH (free flow)
- Flows 120 GPH at 9 PSI
- Maximum pressure is 14 PSI
- 3/8" NPT inlet and outlet ports
- Fuel pressure regulator is required.
 - Recommend **P/N 12-704** for gasoline; **P/N 12-707** for alcohol
- Motor draws only 4 Amps current
- 7 1/2 Amp fuse recommended
- Provides constant fuel flow with no pulsation
- Has externally accessible pressure relief valve (max 14 PSI)
- Rotor/Vane pump design is more tolerant of contaminated fuels
- Weighs only 3 lbs.
- Includes mounting bracket
- Repair kits are readily available
- Can be serviced from either pump end or brush cap end
- Use of safety shut-off switch, **P/N 12-810**, strongly recommended
- Not designed or recommended for use with fuel injection systems

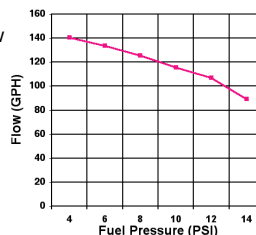

CARBURETORS
FUEL METERING
THROTTLE BODIES
FUEL PUMPS
INLINE MANIFOLDS
SPEEDCHANGERS
CYLINDER HEADS
SYSTEMS
WATER PUMPS
BRESSUP
BATTERY
STREET & TRACK AIRWORK
POINT-OF-SALE
NEW/REPLACEMENT

(A) Not legal for street use in California on vehicles originally equipped with 2-barrel carburetors for which there was no 4-barrel option.

(B) Not legal for sale or use in California on any pollution controlled motor vehicles.

or See page 2 for symbol explanation.

Tech Line: 270-781-9741

153

Fuel Pumps

ELECTRIC FUEL PUMPS - CARBURETED

160 GPH Electric Fuel Pump

Part # **12-705-1**^(B) 



Features

- New shiny finish
- Aluminum billet pump housing/base
- Flows 180 GPH (free flow)
- Pressure is pre-set at 15 PSI
- Compatible with alcohol fuels
- Positive displacement gerotor design
- Must have 3/8" NPT return line to tank
- Includes AN style fittings
- Includes 45 micron fuel inlet screen
- Motor draws only 4 1/2 Amps current
- 7 1/2 Amp fuse recommended
- Fuel pressure regulator required. Recommend **P/N 12-704**
- Provides constant fuel flow with no pulsation
- Includes two (2) 1/2" NPT inlet ports and one (1) 1/2" NPT outlet port
- Has externally accessible pressure relief valve
- **NOT** designed or recommended for use with fuel injection systems
- Service parts are readily available

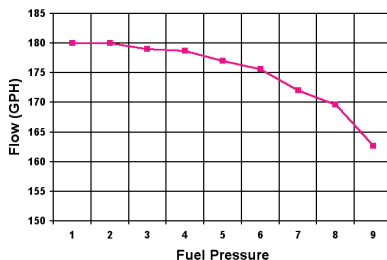

250 GPH Electric Fuel Pump

Part # **12-706-1**^(B) 



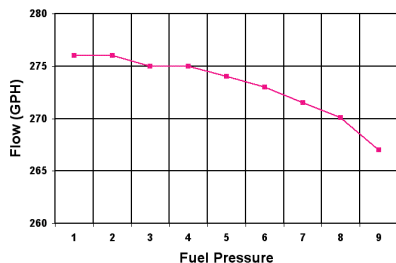

Features

- New shiny finish
- Aluminum billet pump housing/base
- Flows 275 GPH (free flow)
- Pressure is pre-set at 15 PSI
- Compatible with alcohol fuels
- Positive displacement gerotor
- Must have 3/8" NPT return line to tank
- Includes AN style fittings
- Includes 45 micron fuel inlet screen
- Motor draws 10 Amps current
- 15 Amp fuse recommended
- Fuel pressure regulator required. Recommend either **P/N 12-704** or **P/N 12-707**
- Provides constant fuel flow with no pulsation
- Includes two (2) 1/2" NPT inlet ports and one (1) 1/2" NPT outlet port
- Has externally accessible pressure relief valve
- **NOT** designed or recommended for use with fuel injection systems
- **NOT** designed or intended for continuous use
- Service parts are readily available



(A) Not legal for street use in California on vehicles originally equipped with 2-barrel carburetors for which there was no 4-barrel option.

(B) Not legal for sale or use in California on any pollution controlled motor vehicles.

  or  See page 2 for symbol explanation.



350 GPH Electric Fuel Pump

Part # 12-708^(B)



Features

- Flows 375 GPH (free flow)
- Billet components
- High output 6-vane pump with hard-coated rotor
- Custom motor has sealed roller bearings
- Motor draws 10 Amps
- 15 Amp fuse is recommended
- Will run on 12V or 16V systems
- Wear surfaces are specially coated to minimize wear and friction
- Adjustable 10-25 PSI bypass valve included with 3 installation options
 - -10 inlet, -8 outlet, -8 bypass valve ports provided
 - Weighs only 6.4 lbs.
 - Gasoline and alcohol compatible
 - **NOT** designed or recommended for use with fuel injection systems

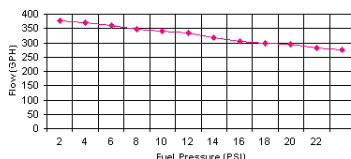

500 GPH Electric Fuel Pump

Part # 12-709^(B)



Features

- Flows 525 GPH (free flow)
- Billet components
- High output 6-vane pump with hard-coated rotor
- Custom motor has sealed roller bearings
- Motor draws less than 14 Amps at 18 PSI
- Will run on 12V or 16V systems
- Wear surfaces are specially coated to minimize wear and friction
- Adjustable 10-25 PSI bypass valve included with 3 installation options
- -12 inlet, -10 outlet, -8 bypass valve ports provided
 - Weighs only 6.4 lbs.
 - Gasoline and alcohol compatible
 - **NOT** designed or recommended for use with fuel injection systems
 - **NOT** intended for continuous use

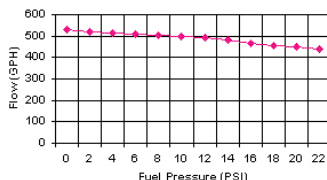

(A) Not legal for street use in California on vehicles originally equipped with 2-barrel carburetors for which there was no 4-barrel option.

(B) Not legal for sale or use in California on any pollution controlled motor vehicles.

or See page 2 for symbol explanation.

CARBURETORS
FUEL METERING
THROTTLE BODIES
FUEL PUMPS
AIR/FLOW METERING
SPECIALTY PARTS
CYLINDER HEADS
SYSTEMS
WATER PUMPS
BRESSUP
BATTERY
STREET & TRACK ACCESSORIES
POINT-OF-SALE
NEW/UPGRADES

Tech Line: 270-781-9741

155

Fuel Pumps

ELECTRIC IN-TANK FUEL PUMPS - FUEL INJECTION

The Holley line of high output in-tank electric fuel pumps is available in flow ratings of 190 and 255 liters of fuel per hour. A 155 liter per hour Mustang pump is available along with 255 liter-per-hour-rated pumps for "forced induction" applications. These particular pumps flow significantly more fuel at higher pressure. For example, at 80 PSI the standard 255 lph pump will flow around 132 liters (35 gallons) per hour. At that same 80 PSI the equivalent forced induction fuel pump will flow over 210 liters (50 gallons) per hour. The chart here aptly illustrates the capabilities of the Holley in-tank electric fuel pumps.

LITERS	GALLONS	LBS. OF FUEL	HORSEPOWER
155	41	246	491
190	50	301	600
255	67	404	800

Holley in-tank electric fuel pumps utilize a proven gerotor design. The outside dimensions, however, are compact enough to fit existing hanger assemblies, without modification. Coverage includes most popular Ford, General Motors, Chrysler and Import applications.

These are complete fuel pump kits and include all drop parts, accessories and installation instructions. Also included is an inlet filter that meets or exceeds original equipment specifications and provides improved filtration and durability.

APPLICATION	YEAR	ENGINE	155 lph	190 lph	255 lph	255 forced induction
Acura Integra	1998-94	1.8L		12-917	12-906	12-916
Buick Regal/ Grand National	1987-84	3.8Turbo V6		12-900	12-903	12-914
Chevrolet Camaro	1992-85	5.0LTPI			12-903	12-914
	1992-85	5.7LTPI			12-903	12-914
Dodge Daytona, Lancer, Shadow, Spirit	1990-85	2.2Turbo		12-905	12-904	
	1990-89	2.5LTurbo		12-905	12-904	
	1990-89	3.0LV6		12-905	12-904	
Dodge Neon	1999-95	2.0L				12-921
Dodge Dakota Truck	1999-96	3.9LV6				12-922
	1999-96	5.2L, 5.9LV8				12-922
Dodge Ram Truck	1997-95	3.9LV6				12-922
	1997-95	5.2L, 5.9LV8				12-922
Eagle Talon	1998-95	2.0Turbo			12-907	12-918
	1994-90	2.0L AWD/turbo			12-911	12-919
Ford Mustang (exc. Cobra)	1997-96	4.6MPI	12-912	12-901	12-902	12-915
	1995-85	5.0LEFI	12-912	12-901	12-902	12-915
Honda Civic	1998-92	1.5L		12-917	12-906	12-916
	1998-92	1.5LVTEC		12-917	12-906	12-916
	1998-92	1.6LVTEC		12-917	12-906	12-916
Mazda RX7	1997-94	1.8LEFI		12-908		
	1992-89	1.3L Rotary/turbo			12-909	
	1992-89	1.3L Rotary			12-909	
Mitsubishi Eclipse	1998-95	2.0L turbo			12-907	12-918
	1994-90	2.0L AWD/turbo			12-907	12-918
Plymouth Acclaim, Caravelle, Reliant, Sundance	1990-85	2.2L turbo		12-905	12-904	
	1990-89	2.5L turbo		12-905	12-904	
	1990-89	3.0LV6		12-905	12-904	
Plymouth Neon	1999-95	2.0L				12-921
Pontiac Firebird & Fiero	1992-85	5.0LTPI			12-903	12-914
	1992-85	5.7LTPI			12-903	12-914
	1986-85	2.8LEFI			12-903	12-914
Toyota Pickup(2WD)	1995-92	2.4L			12-910	
Toyota Supra	1994-86	3.0L				12-913

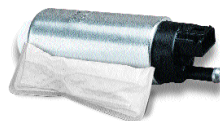



ELECTRIC IN-LINE FUEL PUMPS - FUEL INJECTION

Part#

These Holley universal, in-line fuel pumps are intended for fuel injection systems. They are designed to work in-line, not inside the tank, so installation is a snap. They're all rated for continuous duty service and have been tested up to 2500 hours. The high output versions are great for serious performance work. These pumps should be mounted below the fuel level of the tank for a good gravity feed on the inlet side.

480 PPH @ 15 PSI **12-920**

258 PPH @ 15 PSI **12-927** **NEW!**



Features

- OE-proven design
- Lightweight, compact design
- 3/8" barbed fittings included
- Rubber isolator, mounting clamps and electrical hardware is included

OPTIONAL PARTS & KITS

P/N	Description
26-160	-6 AN fittings
26-180	-8 AN fittings

Approximate Maximum Horsepower

P/N	Throttle Body Injection	Multi-Point Injection	Forced Induction	Flow @ 15 psi (GPH)*	Flow @ 15 psi (PPH)*	Current draw @ 15 psi	Flow @ 45 psi (GPH)*	Flow @ 45 psi (PPH)*	Current draw @ 45 psi	Throttle Body Injection	Multi-Point Naturally Aspirated	Multi-Point Forced Induction
12-920	Y	Y	Y	80	480	5 Amps	67	402	8 Amps	800	700	600
12-927	Y	N	N	43	258	3.5 Amps	N/A	N/A	N/A	400	N/A	N/A

(*) Flow figures at 13.5 Volts.

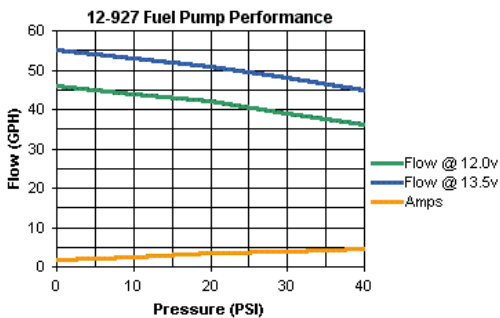
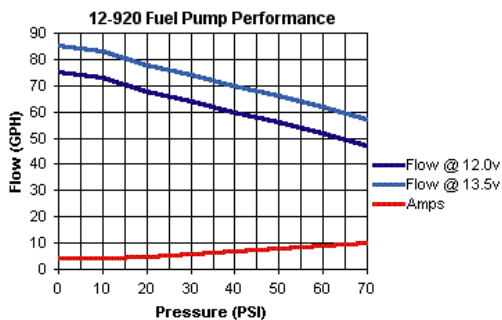

Tech Line: 270-781-9741

157

CARBURETORS
FUEL METERING
THROTTLE BODIES
FUEL PUMPS
INJECTOR MANIFOLDS
SPEEDCHANGERS
CYLINDER HEADS
SYSTEMS
WATER PUMPS
BRESS-UP
BATTERY
STREET & TRUCK AIRFLOW
POINT-OF-SALE
NEW/UPGRADING

Fuel Pumps

Carburetor Fuel Pressure Regulators

Part #

12-501



Features

- 3/8" NPT ports
- .220" (7/32") restriction
- Includes mounting bracket
- Low Pressure (1-4 PSI)
- High Pressure (4-1/2-9 PSI)

PSI	Finish	Part #
4 1/2 - 9	Satin	12-803^(B)
4 1/2 - 9	Chrome	12-501^(B)
1-4 PSI	Satin	12-804^(B)
1-4 PSI	Chrome	12-500^(B)

12-704



Features

- Regulates from 4-1/2 to 9 PSI
- One 1/2" NPT inlet and two 1/2" NPT outlet ports
- .437" (7/16") restriction
- Includes mounting hardware and AN style fittings

12-704^(B)

12-707



Features

- Regulates from 4-1/2 to 9 PSI
- One -8 inlet port and four -6 outlet ports
- .437" (7/16") restriction
- Aluminum billet body and top casting cover are hard coat anodized
- Three fuel pressure gauge mounting options (fuel pressure gauge not included)
- Includes mounting hardware and AN style fittings
- Compatible for use with methanol/alcohol

12-707^(B)

Fuel Line Safety Valve

Part # **10-10038**



10-10038

This safety valve is designed to mount between the fuel pump and fuel cell or tank of a vehicle. It opens by vacuum as the pump draws fuel from the tank or cell. It is non-restrictive and can flow up to 180 gallons per hour. Should the fuel pump or engine stop running or the fuel line become disconnected, the valve instantly closes and prevents additional fuel from escaping from the tank or cell. In case of an accident, fuel will be prevented from puddling onto the ground, under the vehicle. It also prohibits possibility of fire traveling through the fuel line to the tank. The Holley fuel line safety valve is probably the single most important safety device that you can install on your vehicle.



ADJUSTABLE FUEL PRESSURE REGULATOR Part # 512-504-5

This precision adjustable fuel metering regulator is the ultimate fuel pressure control unit designed to work on all naturally aspirated EFI, turbo and supercharged applications like vehicles that run in the Pro Street, Pro Import and Outlaw classes. This is a 2 port 1:1 boost compensating return style regulator that is adjustable from 15-65 PSI + boost reference and is designed to be used in conjunction with any electric EFI fuel pump. Features built in gauge port, mounting bracket, two AN -8 O-ring fittings and a AN-6 O-ring return fitting. All racing regulators come Black hard anodized for ultimate durability.

Key Features:

- Designed to regulate high fuel demands for naturally aspirated EFI, turbo, supercharged and NOS race applications.
- Engineered to regulate extreme flow volumes generated by racing fuel systems.
- Allows adjustment from 15-65 PSI + boost reference.
- Precision CNC machined 6061 T-6 Billet aluminum.
- -8AN & -6AN O-Ring style fittings included to adapt to steel braided fuel lines.
- Includes detailed installation instructions.



FUEL MANAGEMENT CONTROLLER Part # 512-505

This Fuel Management unit is designed to run in conjunction with the factory fuel pressure regulator. This is the ultimate manual fuel management control unit and is installed in series with a stock regulator in the return line back to the tank. The unit increases fuel pressure in proportion to boost pressure up to a 4:1 Idle/WOT pressure ratio depending on which included adjustable disks you select. This add on upgrade is ideal to be used with aftermarket turbo and supercharger kits that require additional fuel pressure volume as the boost pressure increases. This unit is adjustable from 20-75 PSI, offers two fuel pressure slope settings and is recommended to be used in conjunction with any Holley High volume EFI fuel pump. All Fuel management units are produced from precision CNC machined billet aluminum and include detailed installation instructions.

Key Features:

- Supplies increasing fuel ratios in respect to boost produced by turbos and superchargers.
- Designed to supply additional fuel for aftermarket turbo and supercharger applications.
- Engineered to regulate extreme flow volumes generated by racing fuel systems.
- Allows adjustment from 20-75 PSI + boost reference.
- Precision CNC machined 6061 T-6 Billet aluminum.
- -6 AN fittings included.
- Includes detailed installation instructions.

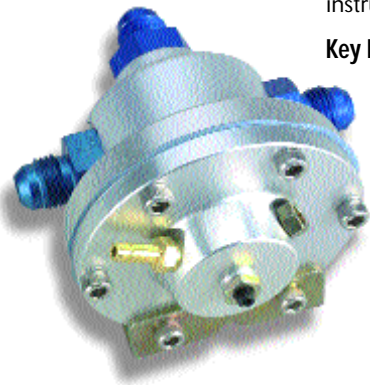

CARBURETORS
FUEL METERING
THROTTLE BODIES
FUEL PUMPS
INJECTOR MANIFOLDS
SUPERCHARGERS
CYLINDER HEADS
SYSTEMS
WATER PUMPS
BRESSUP
BATTERY
STREET & TRUCK AIRWORKS
POINT-OF-SALE
NEW/UPGRADING

Tech Line: 270-781-9741

Fuel Pumps

EFI FUEL PRESSURE REGULATORS

Holley fuel injection pressure regulators are designed to provide the correct fuel pressure for any high performance fuel injected vehicle. Regulators for dedicated applications are offered in various colors. These each feature a range of adjustability from 35-65 PSI. They're made to bolt in the stock location, so installation is a snap!

Year	Application	Engine	P/N Clear Coat	P/N Red	P/N Blue
1997-99	Acura CL	4 cyl.	512-506	512-506-1	512-506-2
1986-00	Acura Integra	All	512-506	512-506-1	512-506-2
1986-95	Acura Legend	All	512-506	512-506-1	512-506-2
1996-00	Acura NSX	All	512-506	512-506-1	512-506-2
1995-98	Acura TL	All	512-506	512-506-1	512-506-2
1992-94	Acura Vigor	All	512-506	512-506-1	512-506-2
1984 - 87	Buick GN	3.8L Turbo	N/A	512-503-1*	N/A
1984 - 87	Buick Regal	3.8L Turbo	N/A	512-503-1*	N/A
1994 - 97	Chevrolet Camaro	LT1/LT4	512-502	512-502-1	N/A
1993	Chevrolet Camaro	LT1/LT4	512-507	512-507-1	N/A
1985 - 92	Chevrolet Camaro	5.0LTPI	512-501	N/A	N/A
1992 - 96	Chevrolet Corvette	LT1/LT4	512-507	512-507-1	N/A
1994 - 95	Chevrolet Impala SS	LT1	512-502	512-502-1	N/A
1986 - 94	Ford Mustang	5.0LEFI	N/A	512-500-1*	N/A
1986 - 94	Ford Mustang	5.0LEFI	512-509	512-509-1	512-509-2
1990-00	Honda Accord	4 cyl.	512-506	512-506-1	512-506-2
1989 - 00	Honda Civic	EFI	512-506	512-506-1	512-506-2
1989-91	Honda CRX	EFI	512-506	512-506-1	512-506-2
1993-97	Honda Del Sol	All	512-506	512-506-1	512-506-2
1989-00	Honda Prelude	All	512-506	512-506-1	512-506-2
2000-01	Honda S2000	All	512-506	512-506-1	512-506-2
1993 - 97	Pontiac Firebird	LT1/LT4	512-502	512-502-1	N/A
1985 - 92	Pontiac Firebird	5.0LTPI	512-501	N/A	N/A

* Stamped steel construction with powder coated finish. All others are true CNC billet



512-506



512-509-1

Universal In-Tank Multi-Point Fuel Pick-Up Kit

Part # **12-951**



Holley introduces another ingenious solution for fuel starvation problems for vehicles with non-baffled fuel tanks or off-road vehicles (jeeps, trucks, SUVs, etc.). This Holley kit uses multiple fuel pick-up points within the fuel cell. Using multiple fuel pick-up points within a fuel cell insures that at least one point will always be covered by fuel. A one-way check valve prevents any air from being sucked into the fuel system. Can be used in conjunction with either a mechanical or electric pump. Holley offers a high output 255 liters per hour, in-line electric fuel pump for this purpose, under P/N 12-920.



ELECTRIC FUEL PUMP ACCESSORIES

Part #

30 Amp Fuel Pump Relay Kit

12-753



This Holley kit is intended primarily for those applications running an electric pump. The long wire runs in these kinds of installations can sometimes result in a voltage drop at the electric pump. Installation of this kit is good insurance that the fuel pump will be receiving full voltage from the battery.

Holley P/N 12-753 can be used with any electric fuel pump, as long as the current load is not above 30 Amps. It will work with 12, 16 and 24 Volt electrical systems and comes equipped with 12 AWG wires that provide extra current-carrying capacity with minimal voltage loss. A 30 Amp relay is included with a relay socket wired with long leads specifically designed to reduce the number of splices required. Quality insulated crimp connectors are provided to make the necessary splices, where required. Detailed instructions are included.

Pulse-Modulated Fuel Pump Controller

12-754

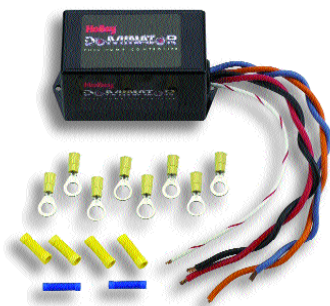

Here's a kit that's designed to regulate current flow to an electric fuel pump, based on the engine's fuel demand. It's driver-activated and it acts to reduce electric current flow by using pulse modulations to electronically turn power on and off to the pump. When the controller is switched off, continuous full current is restored to the pump for maximum fuel output. Using this Holley kit will help you to optimize fuel delivery while minimizing battery drain by reducing the fuel pump's current draw at idle and while driving in the pits.

This Holley Pulse-Modulated Fuel Pump Controller provides efficient power management for electric fuel pumps that have a high amperage draw. This reduced electrical drain from the fuel pump allows use in turn, of a smaller, lighter battery with or without a charging system, ensuring adequate electrical power for high-energy electronic ignition systems. A must for drag racers!

This Holley kit reduces fuel pressure and volume, reducing the tendency of high volume, high pressure fuel pumps to cause engines to flood while at idle or part throttle. This also improves fuel pump reliability and longevity by allowing the pump to operate at less than 100 percent capacity when desired. The Holley Pulse-Modulated Fuel Pump Controller is compatible with a wide range of electric fuel pumps.

CHARACTERISTICS

FUEL

THROTTLE

FUEL PUMPS

ENGINE

SPECIFICATIONS

CYCLING

SYSTEMS

WATER

DRESS-UP

BATTERY

STREET & TRACK

POINT-OF-SALE

NEW/

REPLACEMENT

Tech Line: 270-781-9741

161

Fuel Pumps

Electric Fuel Pump Service Kits



A.

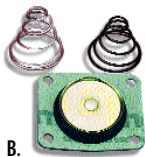

B.

12-801-1 (red), 12-802-1 (blue), and 12-815-1 (black) Fuel Pumps

PART NO.	DESCRIPTION	APPLICATION
A. 12-805	Check valve kit	12-801, -1 pump
A. 12-806	Check valve kit	12-802, -1 pump
A. 12-816	Check valve kit	12-815, -1 pump
B. 12-807	Diaphragm repair kit	12-803, 12-804 regulators
C. 12-808	Lower housing/seal kit	12-801, -1, 12-802, -1 pumps
C. 12-817	Lower housing/seal kit	12-815, -1 pump
D. 12-810	Safety pressure switch	All electric pumps
E. 12-811	Rotor and vane kit	12-801, -1, 12-802, -1 pumps
F. 12-855	Armature cap and brush kit	12-801, -1, 12-802, -1 pumps
G. 36-183	Master repair kit and parts assortment	12-801, -1, 12-802, -1 pumps



C.

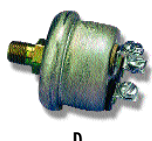

D.



E.



F.

12-705-1 and 12-706-1 VOLUMAX Fuel Pumps

PART NO.	DESCRIPTION	APPLICATION
H. 12-750	Lower housing/seal and gasket kit	12-705, 12-706 pumps
I. 12-751	Gasket kit	12-705, 12-706 pumps



G.



H.

Fuel Pump Block-Off Plates – Chrome

PART NO.	DESCRIPTION	APPLICATION
J. 12-813	Mechanical fuel pump mounting pad cover	Big block Chrysler Small block Chrysler
K. 12-814	Mechanical fuel pump mounting pad cover	Big block Chevrolet Small block Chevrolet



I.



J.



K.

VOLUMAX Regulator Service Parts



L.



M.

PART NO.	APPLICATION
L. 12-752	Diaphragm
26-90	O-ring Kit
M. 26-88	(-8 AN) Fitting
M. 26-117	(-12 AN) Fitting